

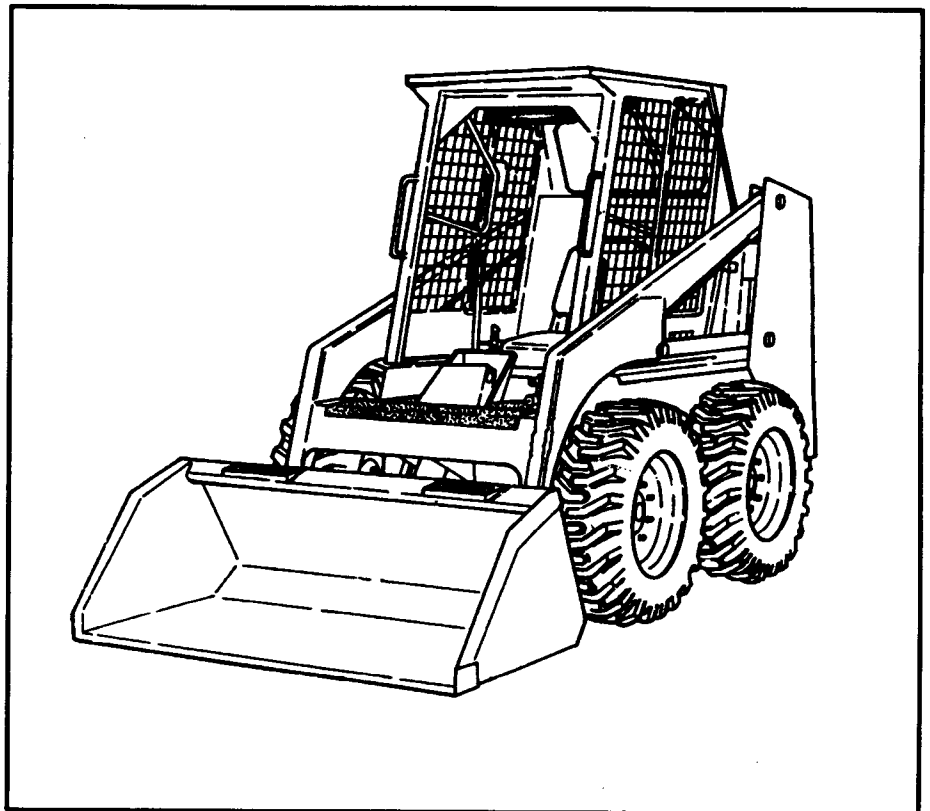

# Service Manual

741 (S/N 501720001 & Above),  
742 (S/N 501820001 – 501822999),  
743 (S/N 501920001 & Above) &  
743DS (S/N 502551001 & Above)



**MELROE**  
**INGERSOLL-RAND**

6566109(4-88)

Printed in U.S.A.



© Melroe Company 1997

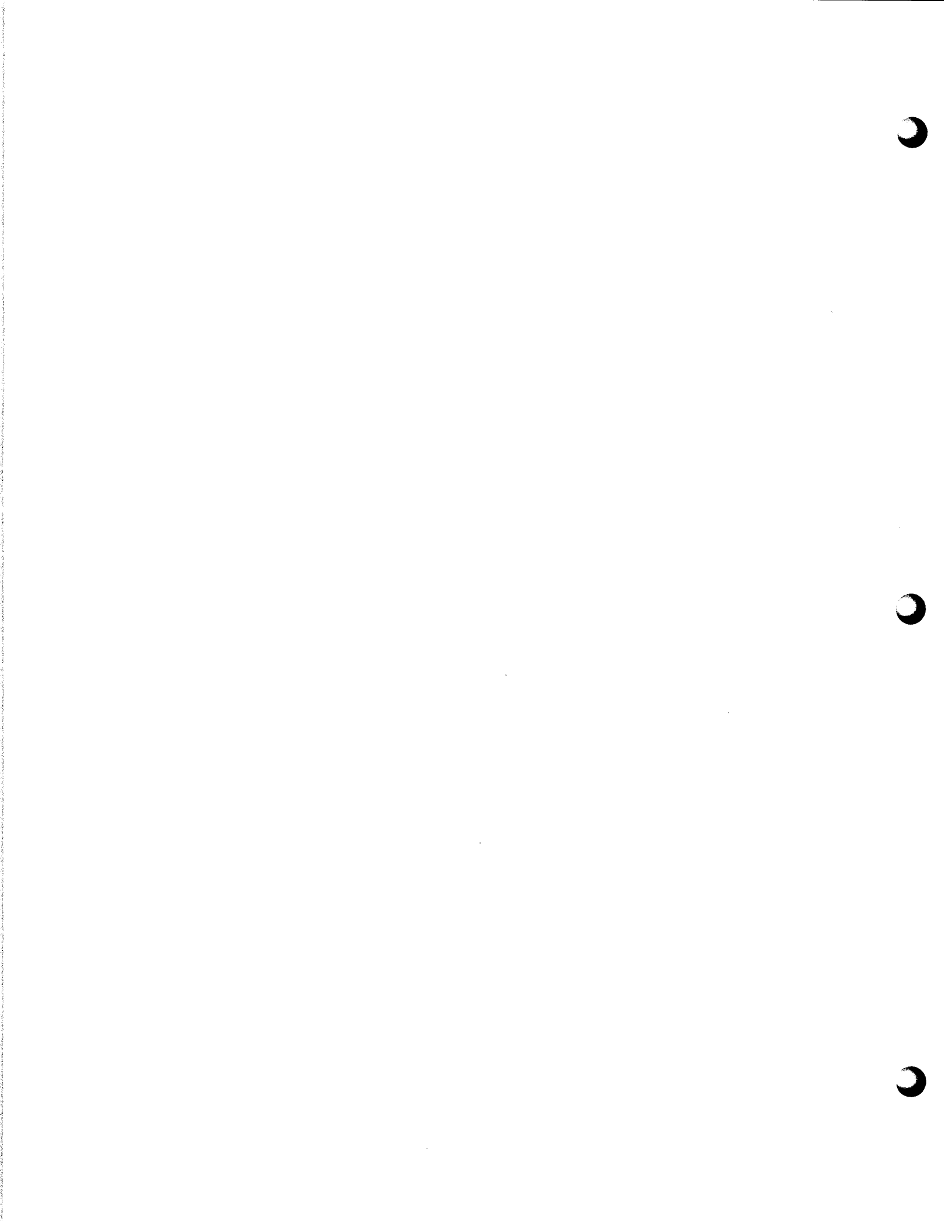

# MAINTENANCE SAFETY

## ⚠ WARNING

Instructions are necessary before operating or servicing machine. Read and understand the Operation & Maintenance Manual, Handbook and signs (decals) on machine. Follow warnings and instructions in the manuals when making repairs, adjustments or servicing. Check for correct function after adjustments, repairs or service. Untrained operators and failure to follow instructions can cause injury or death.

W-2003-0199

⚠ **Safety Alert Symbol:** This symbol with a warning statement, means: "Warning, be alert! Your safety is involved!" Carefully read the message that follows.

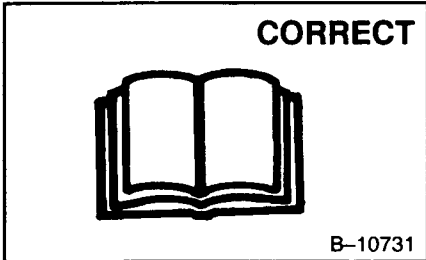

⚠ Never service the Bobcat® Skid Steer Loader without instructions.

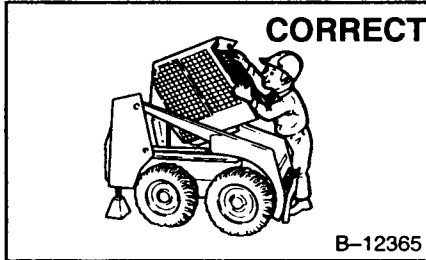

⚠ Use the correct procedure to lift or lower operator cab.

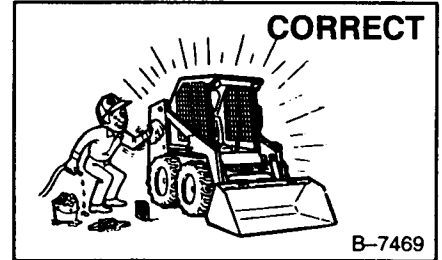

⚠ Cleaning and maintenance are required daily.

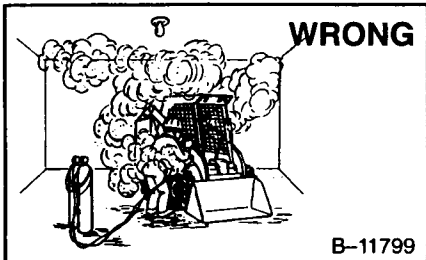

⚠ Have good ventilation when welding or grinding painted parts.  
 ⚠ Wear dust mask when grinding painted parts. Toxic dust and gas can be produced.  
 ⚠ Avoid exhaust fume leaks which can kill without warning. Exhaust system must be tightly sealed.

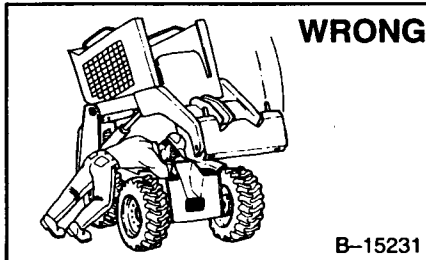

⚠ Disconnecting or loosening any hydraulic tubeline, hose, fitting, component or a part failure can cause lift arms to drop. Do not go under lift arms when raised unless supported by an approved lift arm support device. Replace if damaged.

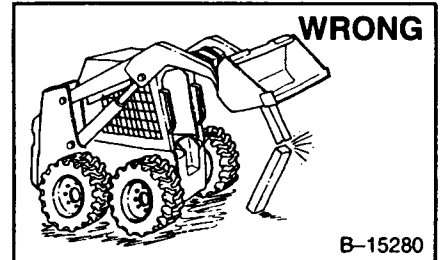

⚠ Never work on loader with lift arms up unless lift arms are held by an approved lift arm support device. Replace if damaged.  
 ⚠ Never modify equipment or add attachments not approved by Bobcat Company.

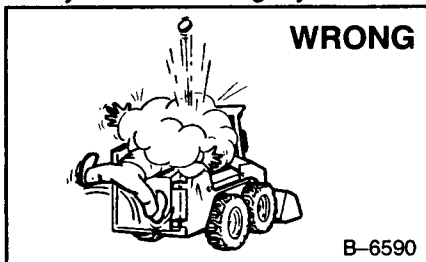

⚠ Stop, cool and clean engine of flammable materials before checking fluids.  
 ⚠ Never service or adjust loader with the engine running unless instructed to do so in the manual.  
 ⚠ Avoid contact with leaking hydraulic fluid or diesel fuel under pressure. It can penetrate the skin or eyes.  
 ⚠ Never fill fuel tank with engine running, while smoking or when near open flame.

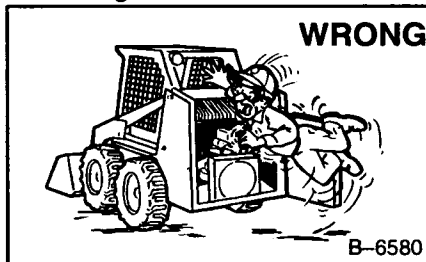

⚠ Keep body, jewelry and clothing away from moving parts, electrical contacts, hot parts and exhaust.  
 ⚠ Wear eye protection to guard from battery acid, compressed springs, fluids under pressure and flying debris when engines are running or tools are used. Use eye protection approved for type of welding.  
 ⚠ Keep rear door closed except for service. Close and latch door before operating the loader.



⚠ Lead-acid batteries produce flammable and explosive gases.  
 ⚠ Keep arcs, sparks, flames and lighted tobacco away from batteries.  
 ⚠ Batteries contain acid which burns eyes or skin on contact. Wear protective clothing. If acid contacts body, flush well with water. For eye contact flush well and get immediate medical attention.

Maintenance procedures which are given in the Operation & Maintenance Manual can be performed by the owner/operator without any specific technical training. Maintenance procedures which are **not** in the Operation & Maintenance Manual must be performed **ONLY BY QUALIFIED BOBCAT SERVICE PERSONNEL**. Always use genuine Bobcat replacement parts. The Service Safety Training Course is available from your Bobcat dealer.

MSW01-0600



# CONTENTS

FOREWORD .....	i
SAFETY INSTRUCTIONS .....	iii
SERIAL NUMBER LOCATIONS .....	iv
DELIVERY REPORT .....	v
BOBCAT LOADER IDENTIFICATION .....	vi
PREVENTIVE MAINTENANCE .....	1-1
HYDRAULIC SYSTEM .....	2-1
HYDROSTATIC SYSTEM .....	3-1
DRIVE SYSTEM .....	4-1
MAIN FRAME .....	5-1
ELECTRICAL SYSTEM .....	6-1
ENGINE SERVICE .....	7-1
SPECIFICATIONS .....	8-1

**PREVENTIVE  
MAINTENANCE**

**HYDRAULIC  
SYSTEM**

**HYDROSTATIC  
SYSTEM**

**DRIVE  
SYSTEM**

**MAIN  
FRAME**

**ELECTRICAL  
SYSTEM**

**ENGINE  
SERVICE**

**SPECIFICATIONS**

**CALIFORNIA  
PROPOSITION 65 WARNING**  
Diesel engine exhaust and some of its  
constituents are known to the State of California  
to cause cancer, birth defects and other  
reproductive harm.



# FOREWORD

This manual is for the Bobcat loader mechanic. It provides necessary servicing and adjustment procedures for the Bobcat loader and its component parts and systems. Refer to the Operation & Maintenance Manual for operating instructions, starting procedure, daily checks, etc.

A general inspection of the following items must be made after the loader has had service or repair:

1. Check that the ROPS/FOPS (Including sidescreens) is in good condition and is not modified.

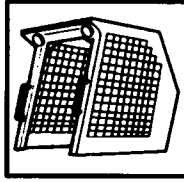

2. Check that ROPS mounting hardware is tightened and is Melroe approved.

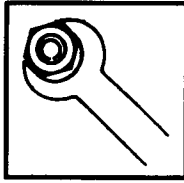

3. The seat belt must be correctly installed, functional and in good condition.

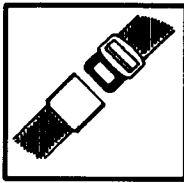

4. The seat bar and pedal interlocks must be correctly adjusted, clean and lubricated.

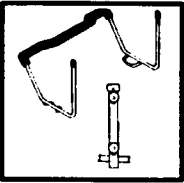

5. Machine signs must be legible and in the correct location.



6. Steering levers and foot pedals must return to neutral.

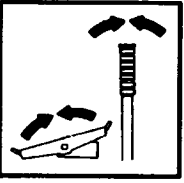

7. Check for correct function of the work lights.

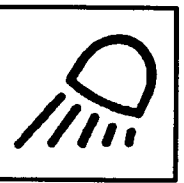

8. The parking brake must function correctly.

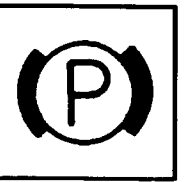

9. Enclosure door latches must open and close freely.

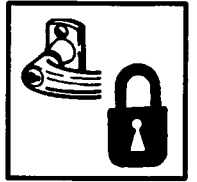

10. Bob-Tach wedges and linkages must function correctly and be in good condition.

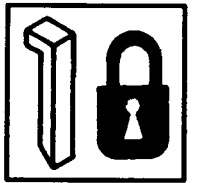

11. Safety treads must be in good condition.

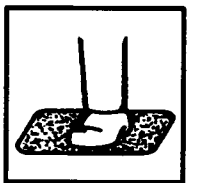

12. Check for correct function of indicator lamps (Optional on some models).

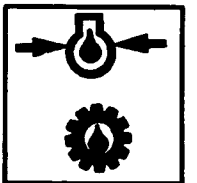

13. Check hydraulic fluid level, engine oil level and fuel supply.

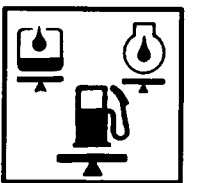

14. Inspect for fuel, oil or hydraulic fluid leaks.

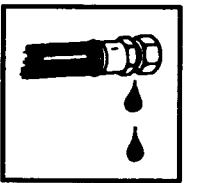

15. Lubricate the loader.



16. Check the condition of the battery and cables.

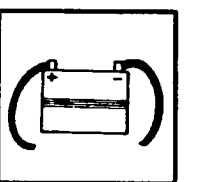

17. Inspect the air cleaner for damage or leaks. Check the condition of the element.

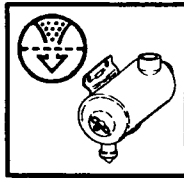

18. Check the electrical charging system.

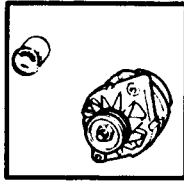

19. Check tires for wear and pressure.

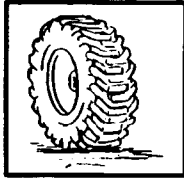

20. Inspect for loose or broken parts or connections.

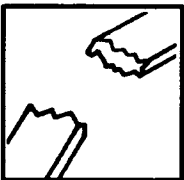

21. Operate the loader and check all functions.

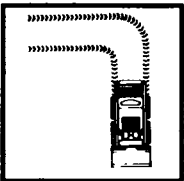

22. Check for any field modification not completed.



23. Check for correct function of the Bobcat Interlock Control System (BICS™) before the machine is returned to the customer.

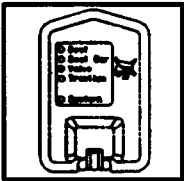

Recommend to the owner that all necessary corrections be made before the machine is returned to service.





## SAFETY INSTRUCTIONS

# WARNING

**Instructions are necessary before operating or servicing machine. Read Operation & Maintenance Manual, Handbook and signs (decals) on machine. Follow warnings and instructions in the manuals when making repairs, adjustments or servicing. Check for correct function after adjustments, repairs or service. Failure to follow instructions can cause injury or death.**

W-2003-1289

The following publications provide information on the safe use and maintenance of the loader and attachments:

- The Delivery Report is used to assure that complete instructions have been given to the new owner and that the machine is in safe operating condition.
- The Operation & Maintenance Manual delivered with the loader gives operating information as well as routine maintenance and service procedures. It is a part of the loader and must stay with the machine when it is sold. Replacement Operation & Maintenance Manuals can be ordered from your Bobcat loader dealer.
- The loader has machine signs (decals) which instruct on the safe operation and care. The signs and their locations are shown in the Operation & Maintenance Manual. Replacement signs are available from your Bobcat loader dealer.
- The loader has a plastic Operator's Handbook fastened to the operator cab. Its brief instructions are convenient to the operator. The handbook is available from your dealer in English edition or French, German, Italian, Dutch & Spanish editions.
- The EMI Safety Manual (available in Spanish) delivered with the loader gives general safety information.
- The Service Manual and Parts Manual are available from your dealer for use by mechanics to do shop-type service and repair work.
- The Skid-Steer Loader Operator Training Course is available through your local dealer. This course is intended to provide rules and practices for correct operation of the Bobcat loader. The course is available in English and Spanish versions.
- The Bobcat Skid-Steer Loader Safety Video is available from your Bobcat Dealer.

## WARNING

**Warnings on the machine and in the manuals are for your safety. Failure to obey warnings can cause injury or death.**

W-2044-1285

## IMPORTANT

**This notice identifies procedures which must be followed to avoid damage to the machine.**

I-2019-0284



**Safety Alert Symbol: This Safety Symbol is used for important safety messages. When you see this symbol follow the safety message to avoid personal injury or death.**

## SAFETY INSTRUCTIONS (Cont'd)

- Wear tight fitting clothing. Always wear safety glasses when maintaining or servicing loader. Safety glasses, hearing protection or loader special applications kit are required for some work. See your dealer for Melroe Safety equipment.
- Know where fire extinguisher and first aid kit are located and how to use them.
- Do not use the Bobcat loader where exhaust, arcs, sparks or hot components can contact flammable material, explosive dust or gases.
- The engine compartment and engine cooling system must be inspected every day and cleaned if necessary to prevent fire hazard and overheating.
- Check all electrical wiring and connections for damage. Keep the battery terminals clean and tight. Repair or replace any damaged part.
- Check fuel and hydraulic tubes, hoses and fittings for damage and leakage. Never use open flame or bare skin to check for leaks. Tighten or replace any parts that show leakage. Always clean fluid spills. Do not use gasoline or diesel fuel for cleaning parts. Use commercial nonflammable solvents.
- Follow any environmental safety regulations when disposing of used fluids such as engine oil, grease or anti-freeze.
- Do not use ether or starting fluids on this engine. It has a glow plug. These starting aids can cause explosion and injure you or bystanders.
- Always clean the loader and disconnect the battery before doing any welding. Cover rubber hoses, battery and all other flammable parts. Keep a fire extinguisher near the loader when welding. Have good ventilation when grinding or welding painted parts. Wear dust mask when grinding painted parts. Toxic dust or gas can be produced.
- Stop the engine and let it cool before adding fuel. No smoking!
- Use the procedure in the Operation & Maintenance or Service Manuals for connecting the battery.

A fire extinguisher is available from your local dealer. The fire extinguisher can be installed in the location shown [A].

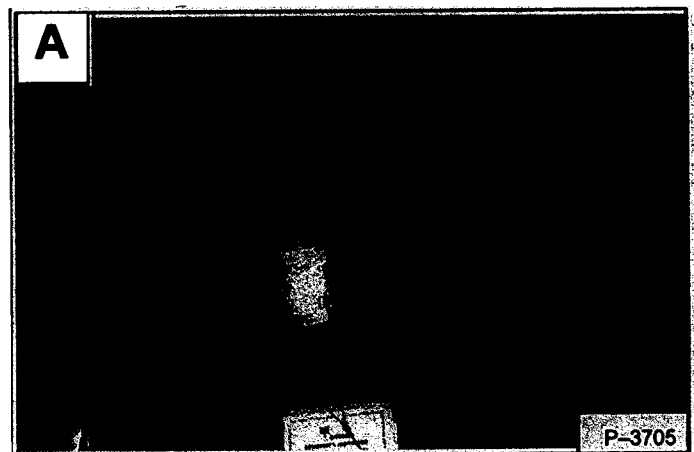

## SERIAL NUMBER LOCATIONS

Always use the serial number of the loader when requesting service information or when ordering parts. Early or later models (identification made by serial number) may use different parts, or it may be necessary to use a different procedure in doing a specific service operation.

### LOADER SERIAL NUMBER

The loader serial number plate is located on the inside of the left upright, above the grill [A].

Explanation of loader Serial Number:

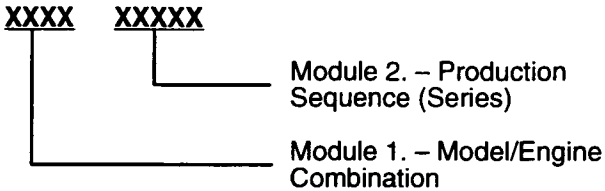

1. The four digit Model/Engine Combination Module number identifies the model number and engine combination.
2. The five digit Production Sequence Number identifies the order which the loader is produced.

### ENGINE SERIAL NUMBER

**741** – The engine serial number is on the blower housing on the right side of the engine [B].

**742** – The engine serial number is on top of the valve cover of the engine [B].

**743, 743DS** – The engine serial number is on the left side of the engine block, near the fuel injection pump [C].

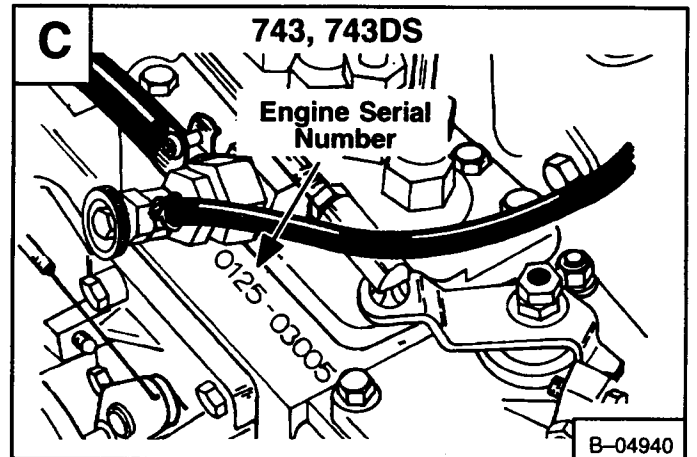
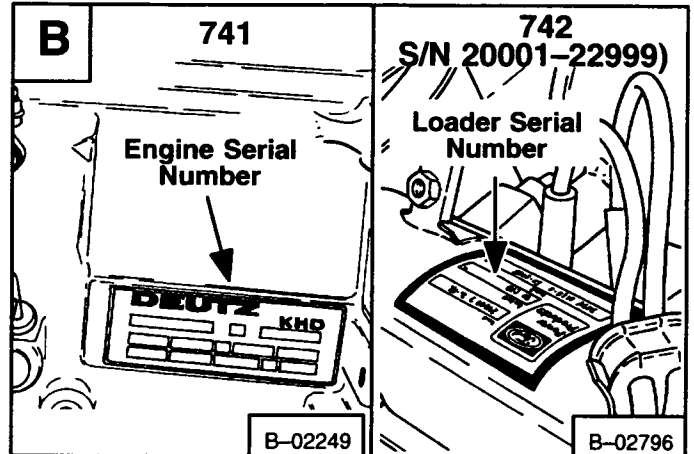
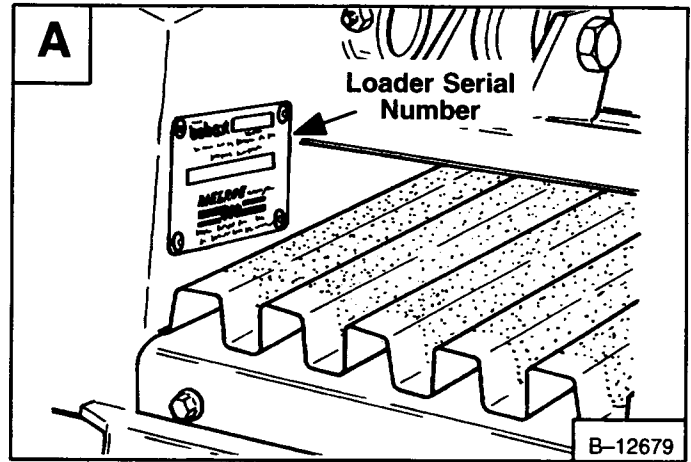

### DELIVERY REPORT

The Delivery Report must be filled out by the dealer and signed by the owner or operator when the Bobcat loader is delivered. An explanation of the form must be given to the owner. Make sure it is filled out completely [D].

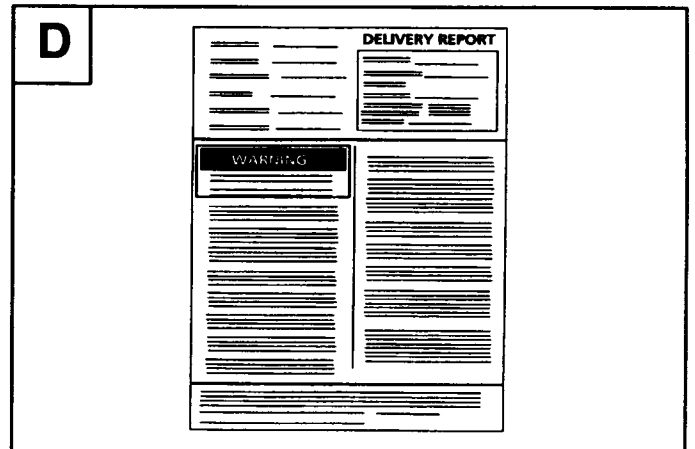

**BOBCAT SKID STEER LOADER IDENTIFICATION**

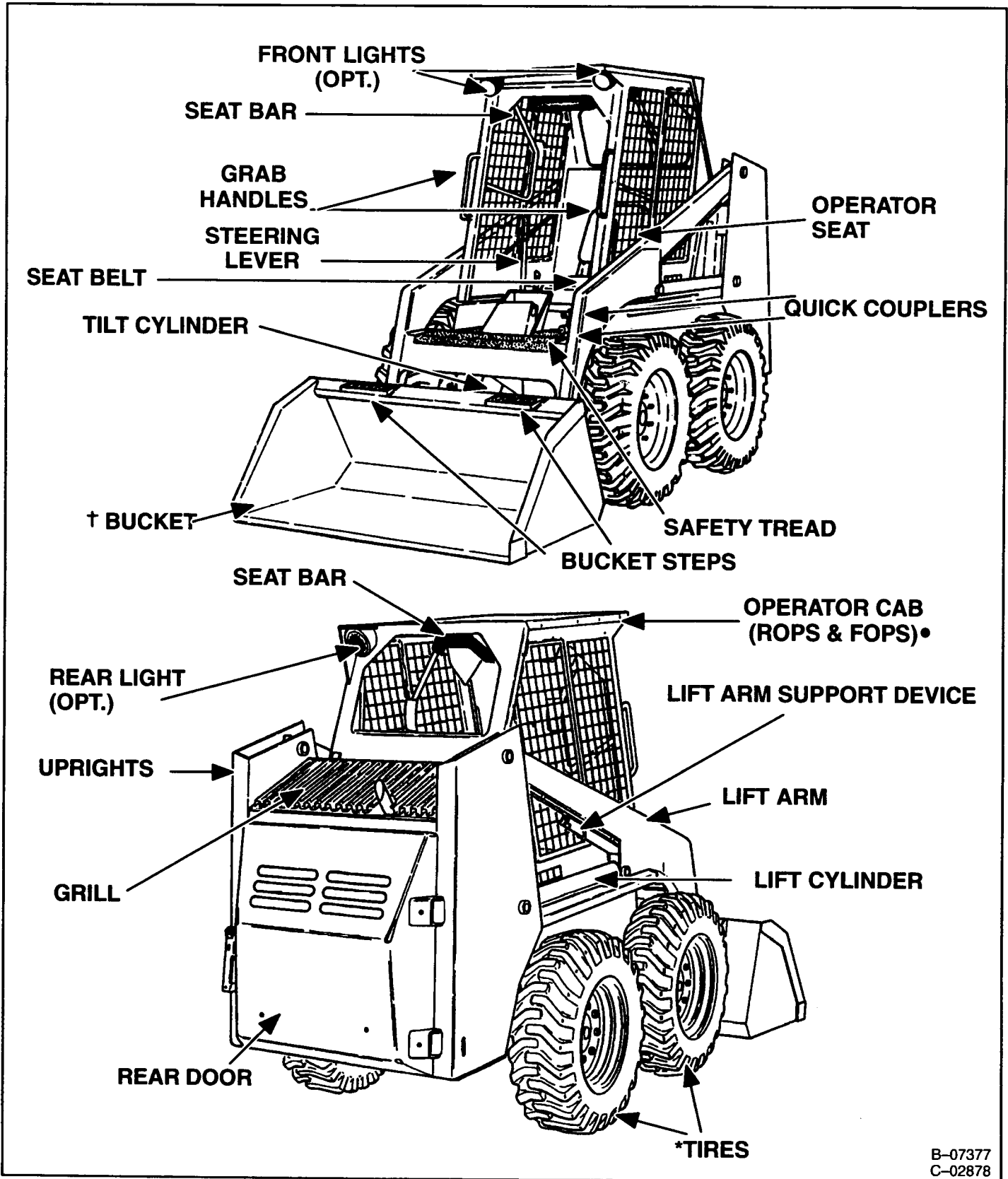

B-07377  
C-02878

- \* TIRES - Flotation tires are shown. THE Bobcat loader is base-equipped with standard tires.
- † BUCKET - Several different buckets and other attachments are available for the Bobcat loader.
- ROPS, FOPS - Roll-Over Protective Structure, Falling Object Protective Structure, per SE J1040 and SAE J1043. The Bobcat loader is base-equipped with a standard operator cab as shown.