

HYDRAULIC / HYDROSTATIC FLOW CHART

For Models

741, 742, 743, 743 DS (S/N 11001 Thru 14999)

With Charge Line Filter and Melroe Valve

Chart # 6570767 (Printed April 1988)

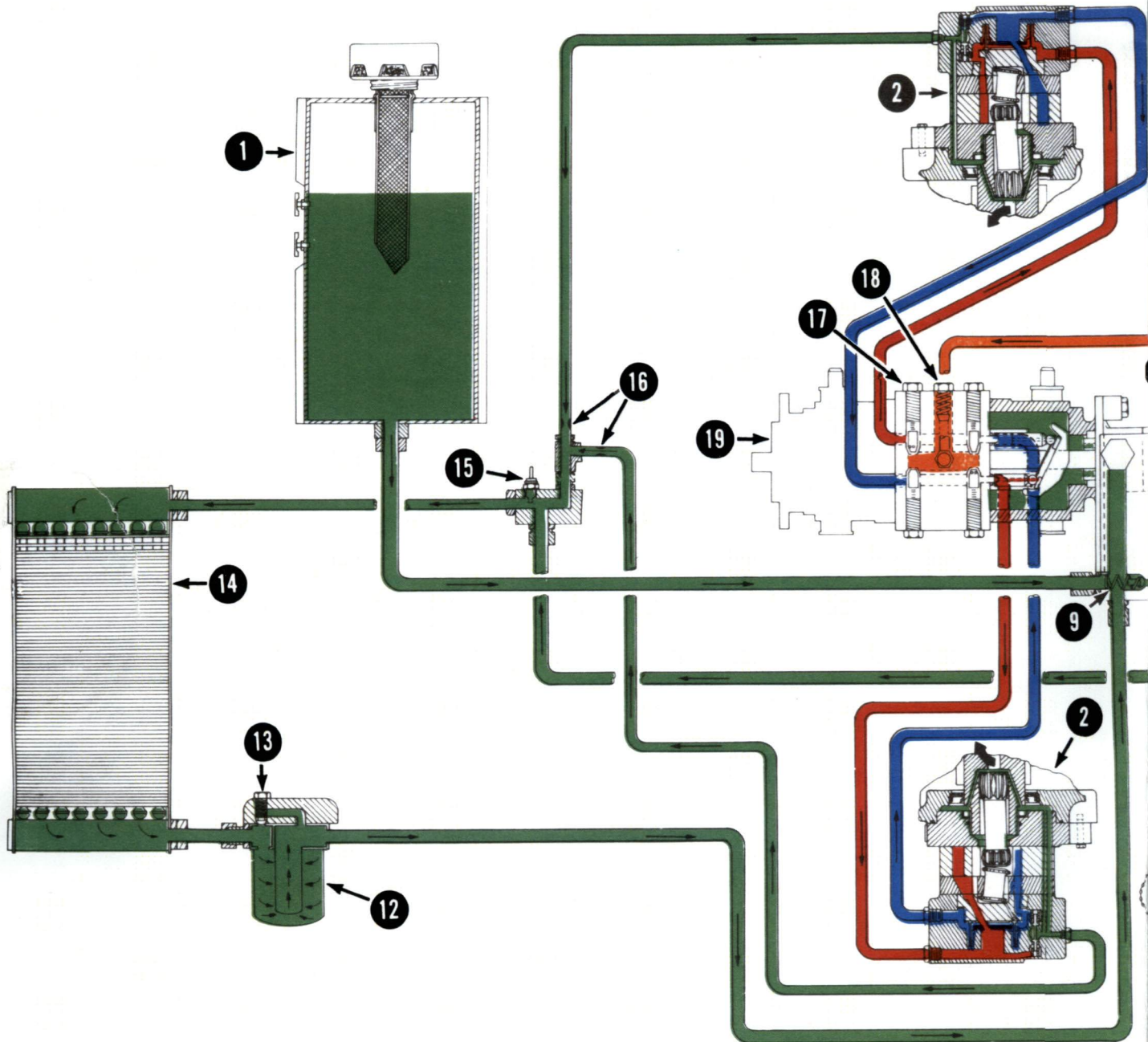

- RED - - - - - High Pressure
- BLUE - - - - - Low Pressure
- GREEN - - - - - Case Drain & Reservoir
- ORANGE - - - - - Charge Pressure

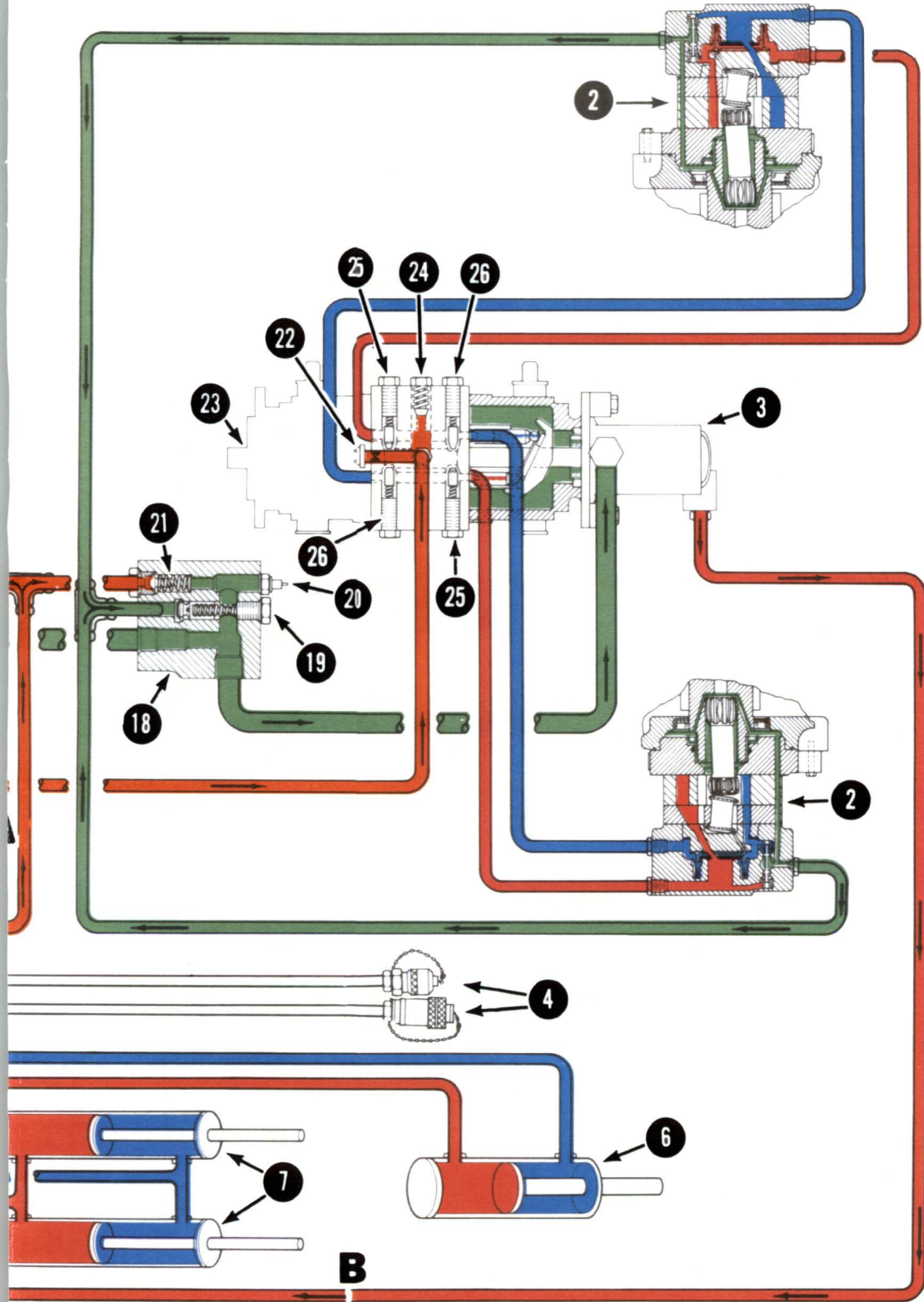



HYDRAULIC / HYDROSTATIC FLOW CHART

For Models

741, 742, 743, 743 DS (Starting With S/N 15001)

With Charge Line Filter and Melroe Valve

Chart # 6570293 (Printed July 1986)

NOTE

Chart shows oil flow in Forward Drive Position and with Hydraulic Cylinders Partially Extended. For Hydraulic/Hydrostatic System Operation, refer to Sheet 2 of this publication.

NOTE

Refer to Chart # 6570281 for machines equipped with optional Bucket Positioning Valve. Reference "A" and "B" indicate location of hydraulic circuitry connection.

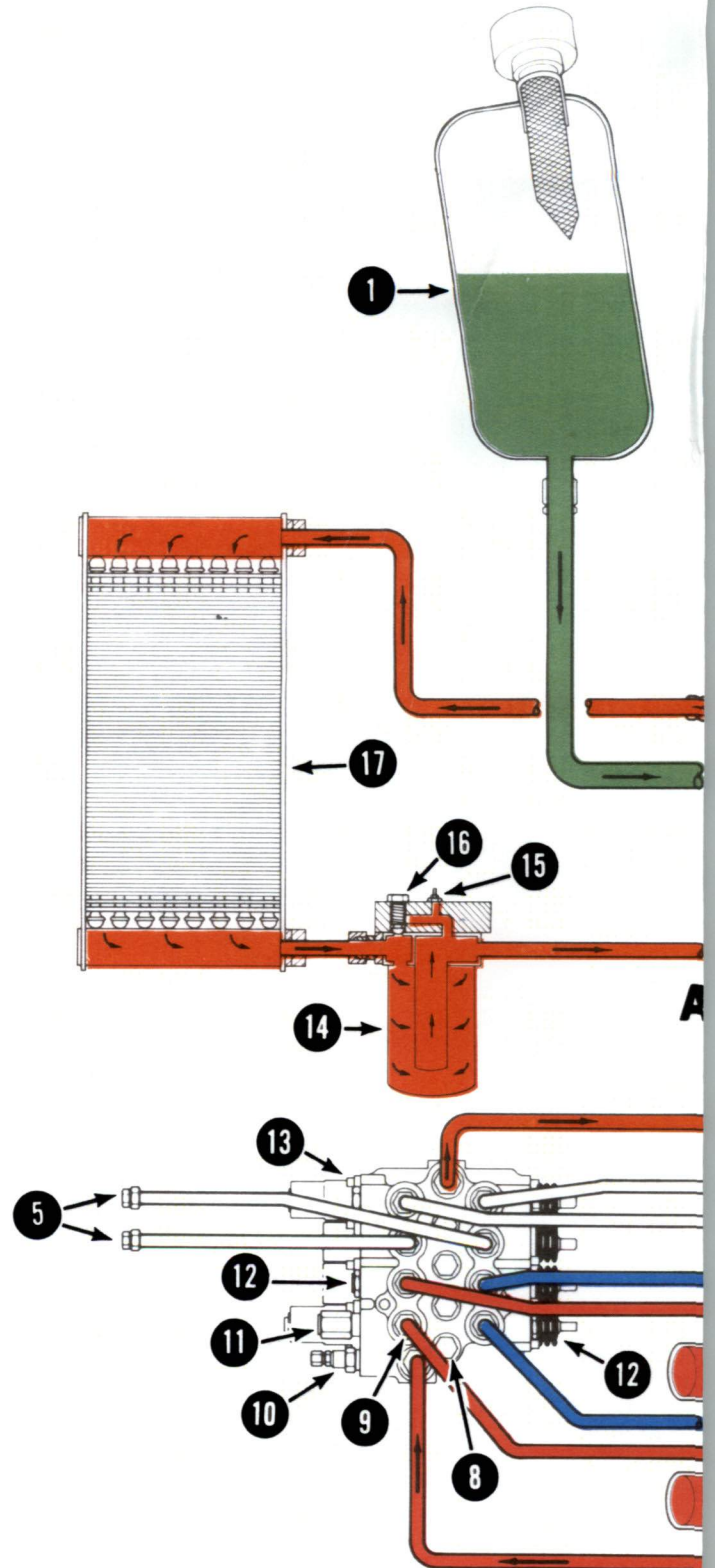

- RED - - - - - High Pressure
- BLUE - - - - - Low Pressure
- GREEN - - - - - Case Drain & Reservoir
- ORANGE - - - - - Charge Pressure

NOTE
 Chart shows oil flow in Forward Drive Position and with Hydraulic Cylinders Partially Extended. For Hydraulic/Hydrostatic System Operation, refer to Sheet 2 of this publication.

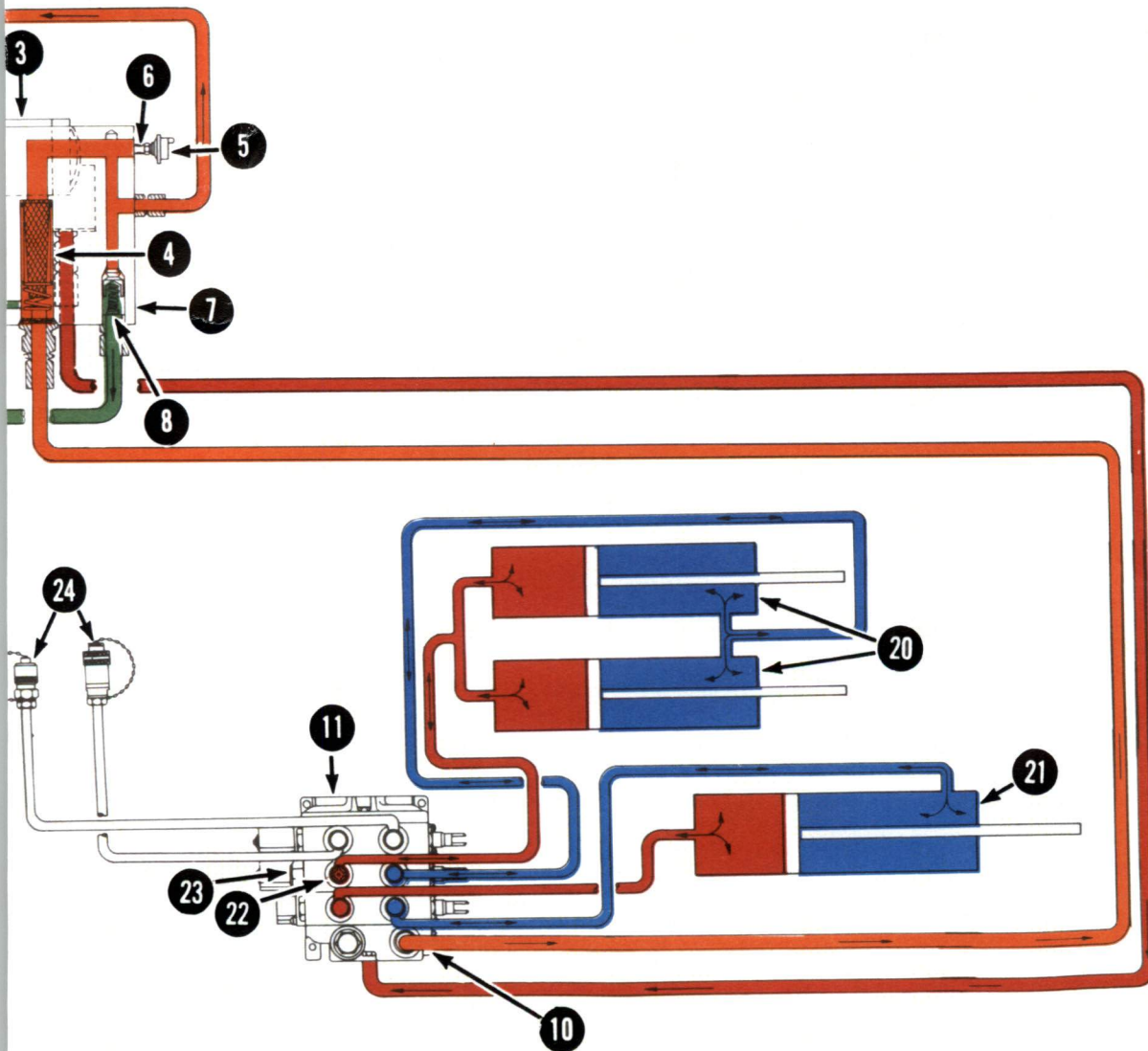

HYDRAULIC / HYDROSTATIC FLOW CHART

For Models

742B, 743B

(With 3-Spool Melroe Control Valve)

Chart # 6722141 (Printed January 1992)



NOTE

Chart shows oil flow in Forward Drive Position and with Hydraulic Cylinders Partially Extended. For Hydraulic/Hydrostatic System Operation, refer to Sheet 2 of this publication.

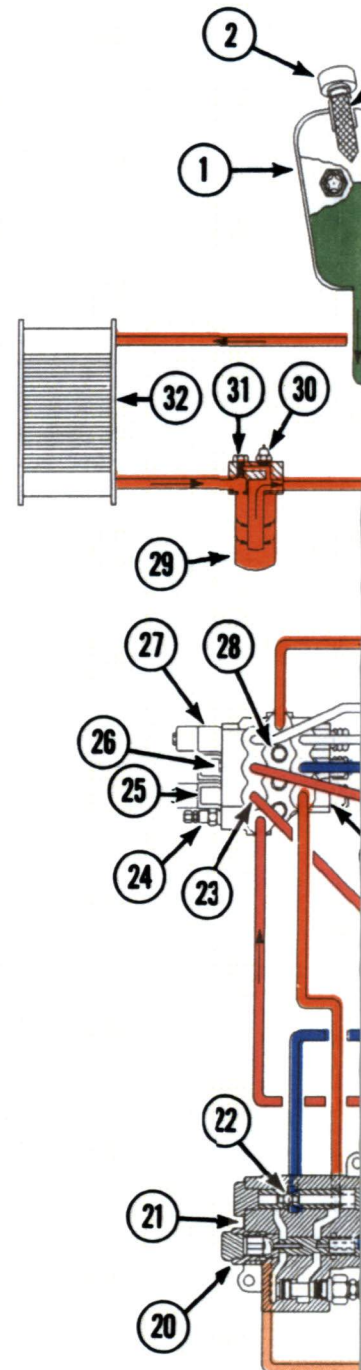

CHART LEGEND

- ① HYDRAULIC CONTROL VALVE (Melroe)
- ② LIFT CYLINDERS
- ③ BUCKET POSITION VALVE (Optional)
- ④ FLOW DIVIDER SPOOL
- ⑤ CHECK POPPET VALVE
- ⑥ FLOW RETURN SPOOL
- ⑦ RELIEF VALVE
- ⑧ TILT CYLINDER

OIL FLOW EXPLANATION

BUCKET POSITIONING SYSTEM OPERATION

When the lift spool of the control valve ① is engaged to raise the lift arms, the fluid from the rod end of the lift cylinders ② is directed through the bucket position valve ③. The bucket position valve has a flow divider spool ④ which directs 20% of the returning fluid directly back to the lift section of the control valve ①. The remaining 80% of the fluid goes through a check poppet valve ⑤ and to the base end of the tilt cylinder ⑧. This forces the tilt cylinder rod out and adjusts the position of the bucket as the lift arms are raised. Since the fluid is trapped in the base end of the tilt cylinder (tilt pedal is in neutral), the pressure will increase and push the flow return spool ⑥ open and allow fluid from the rod end of the tilt cylinder ⑧ to the return to the lift section of the control valve ① along with the 20% of the returning fluid from the rod end of the lift cylinders ②. When the tilt cylinder is fully extended and the lift arms are still raising, fluid goes over the relief valve ⑦ and back to the lift section of the control valve ①.



bobcat

BUCKET POSITION FLOW CHART

For Models

741, 742, 743, 743DS W/Melroe Hydraulic Control Valve

and

Optionally Equipped W/Dukes Bucket Position Valve

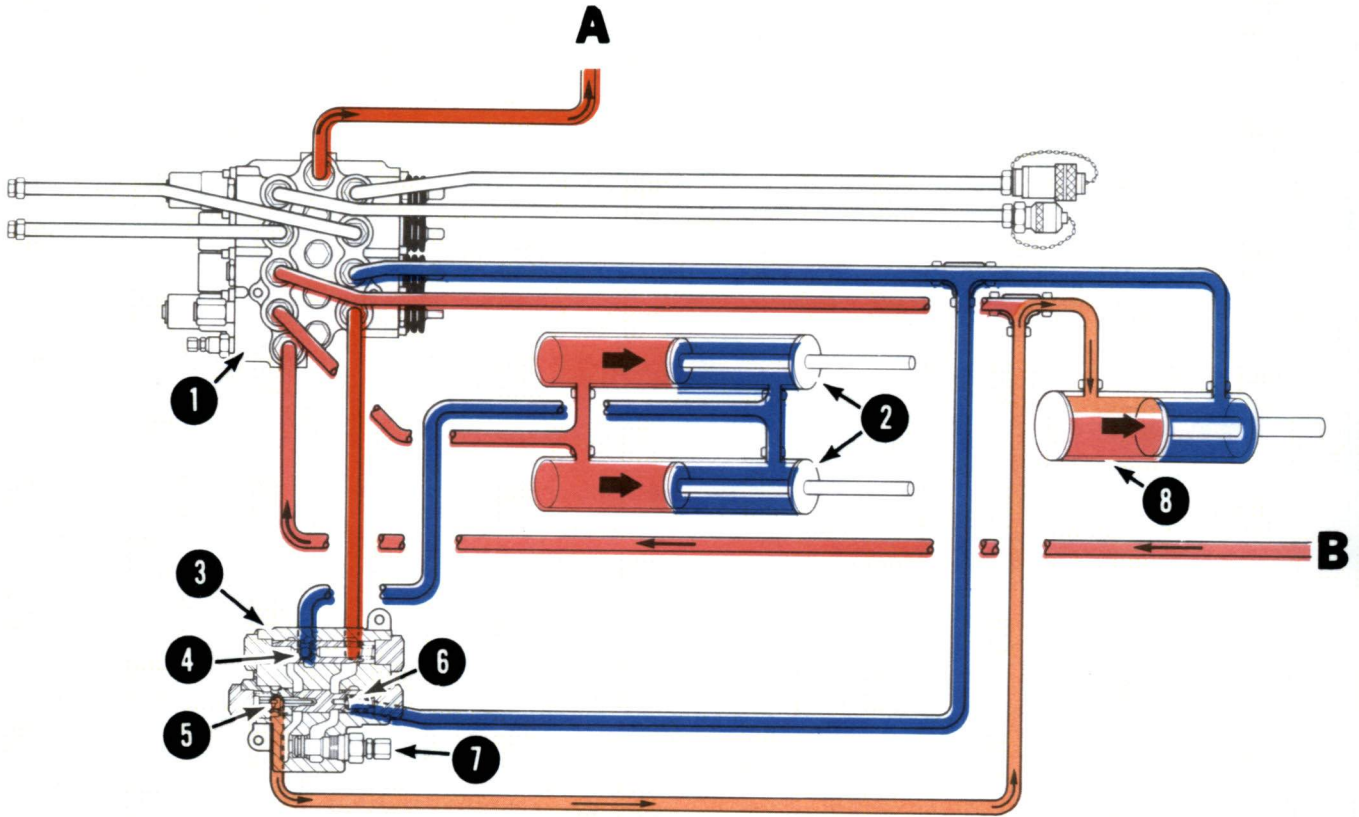

D-1690

NOTE

Chart shows fluid flow in the Lifting Position and with the Bucket Positioning Valve in operation.

NOTE

Use with Hydraulic Chart #6570293. References "A" & "B" indicate location of hydraulic circuitry connection.

- RED - - - - - High Pressure
- BLUE - - - - - Low Pressure
- ORANGE - - - - - Charge Pressure
- LT. ORANGE - - - - - Bucket Position Fluid

- RED - - - - - High Pressure
- BLUE - - - - - Low Pressure
- GREEN - - - - - Case Drain & Reservoir
- ORANGE - - - - - Charge Pressure
- LT. ORANGE - - - - - Bucket Positioning Fluid

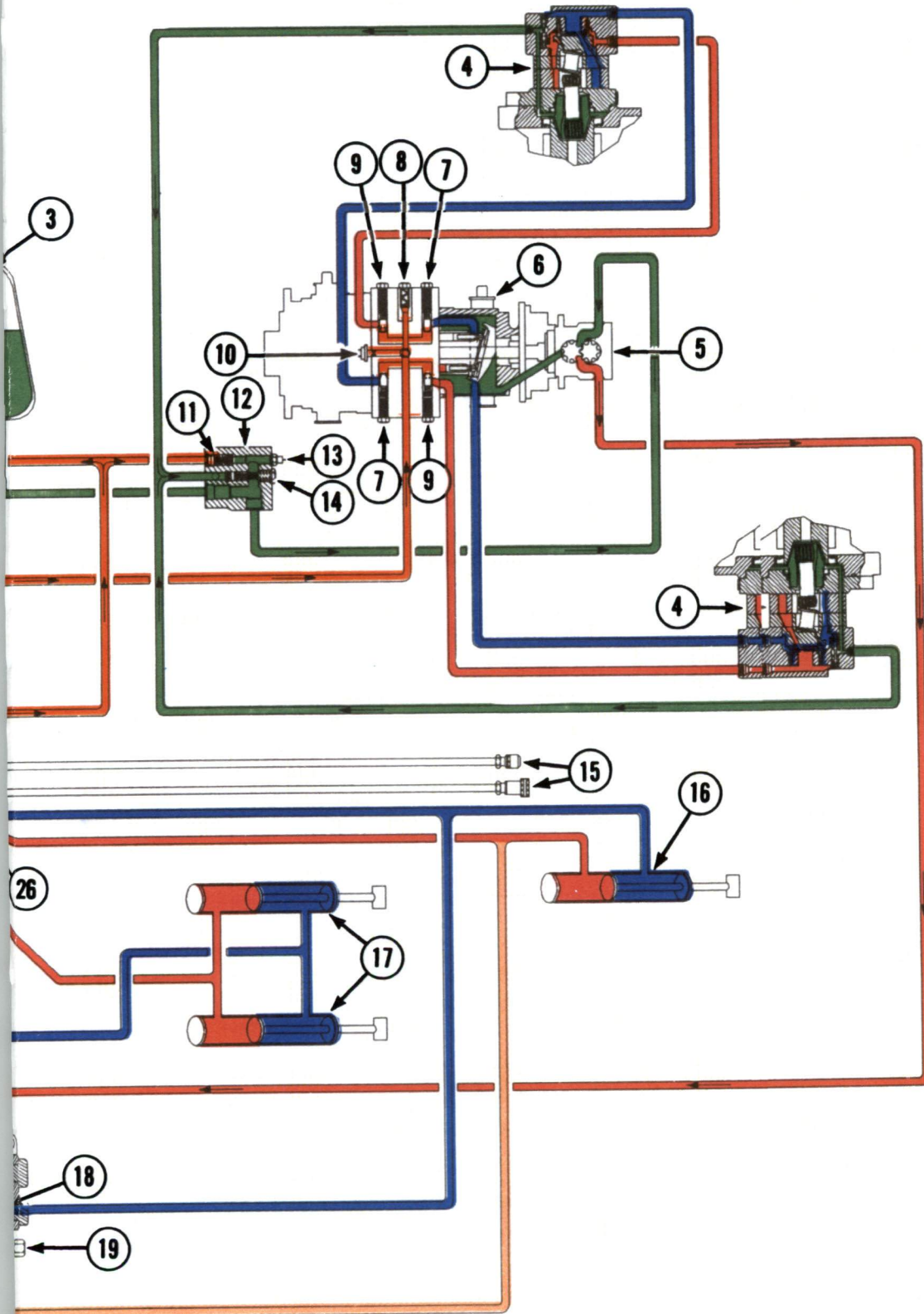

ENGINE WIRING DIAGRAM (P/N 6720564)

Model 743DS

(Printed September 1990)

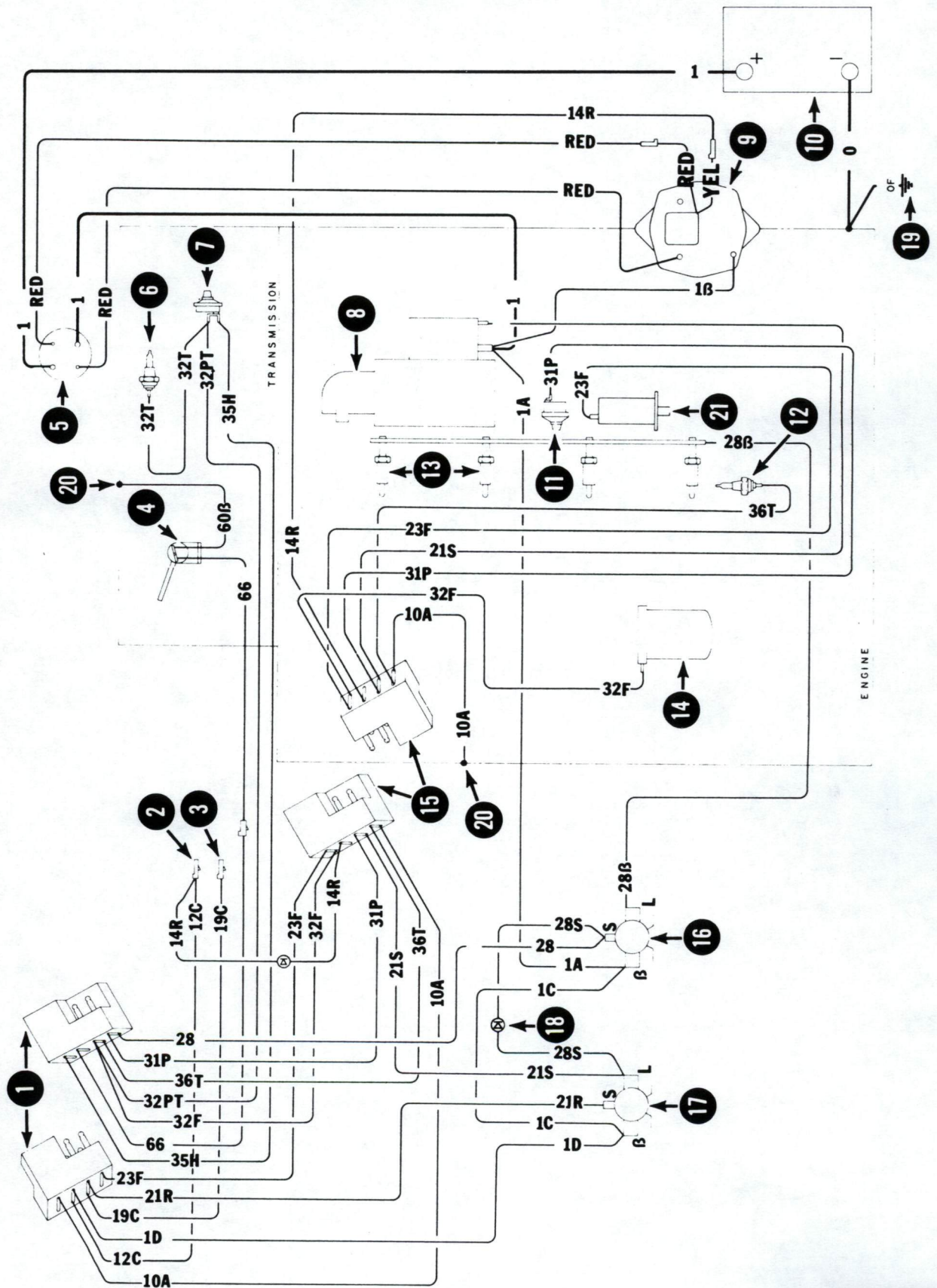

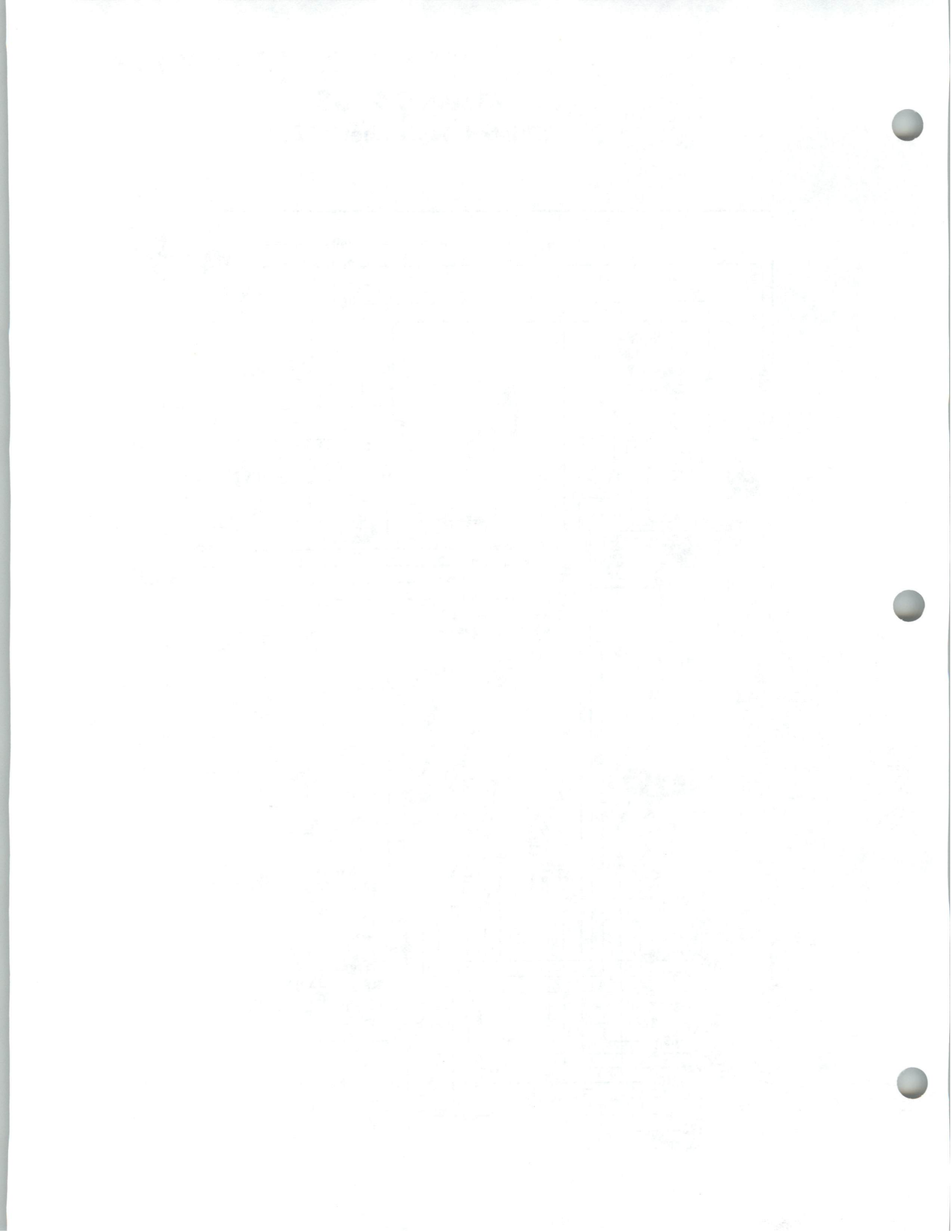

ENGINE HARNESS

743DS (S/N 51378 & Above)

WIRE LEGEND

NO.'s	COLOR	GAUGE	NO.'s	COLOR	GAUGE
0	Black	Cable	60B	Black	16
1	Red	Cable	66	Orange/Green	16
1A	Red	8			
1B	Red	12			
1C	Red	12			
1D	Red	12			
10A	Black	12			
12C	Orange	16			
14F	Lt. Green	16			
14R	Lt. Green/White	16			
19C	Red/White	12			
21R	White	16			
21S	White/Lt. Green	12			
23F	White/Black	16			
28	Lt. Blue/Black	16			
28B	Lt. Blue/Orange	10			
28S	Lt. Blue/Yellow	16			
31P	Yellow/Lt. Green	16			
32F	Yellow/Dk. Blue	16			
32PT	Yellow	16			
32T	Yellow/Black	16			
35H	Yellow/Brown	16			
36T	Purple/White	16			

PARTS LEGEND

- | | | | |
|----|---------------------------------|----|------------------------------------|
| 1 | Operator Cab Harness Connector | 12 | Engine Coolant Temp. Sender |
| 2 | Fused & Switch Accessory | 13 | Engine Glow Plugs |
| 3 | Open, Fused & Live Accessory | 14 | Hyd. Fluid Filter Condition Switch |
| 4 | Back-Up Alarm Switch (Optional) | 15 | Engine Connector |
| 5 | Battery Disconnect Switch | 16 | Pre-Heat Relay |
| 6 | Trans. Oil Temperature Switch | 17 | Starter Relay |
| 7 | Trans. Charge Pressure Switch | 18 | Diode |
| 8 | Starter | 19 | Frame Ground |
| 9 | Alternator | 20 | Engine Ground |
| 10 | Battery | 21 | Fuel Shut-Off Solenoid (Optional) |
| 11 | Engine Oil Pressure Switch | | |

Faint, illegible text, possibly bleed-through from the reverse side of the page.

CAB WIRING DIAGRAM (P/N 6566807)

640, 740 Series

(Printed April 1988)

E-1630

CAB HARNESS

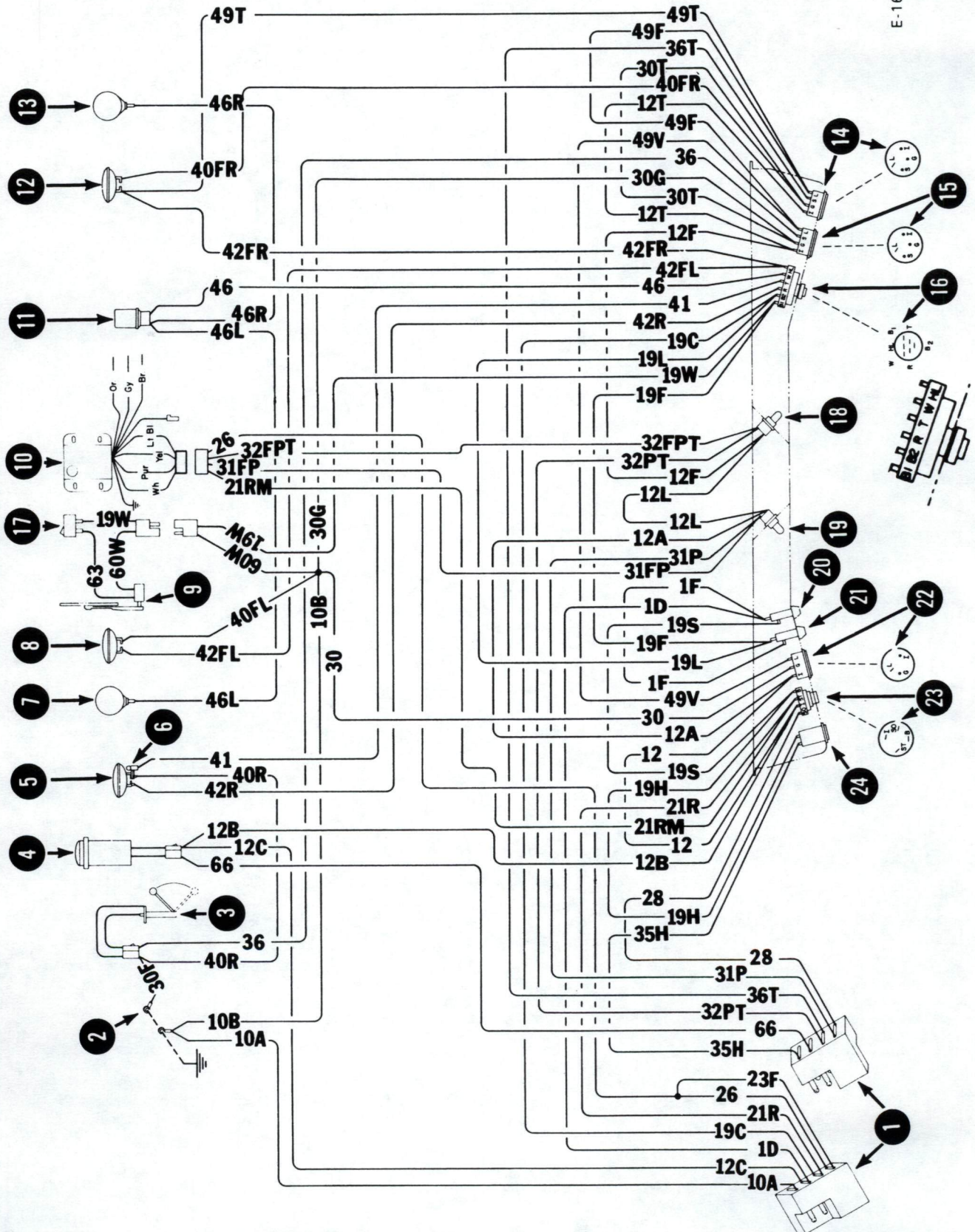

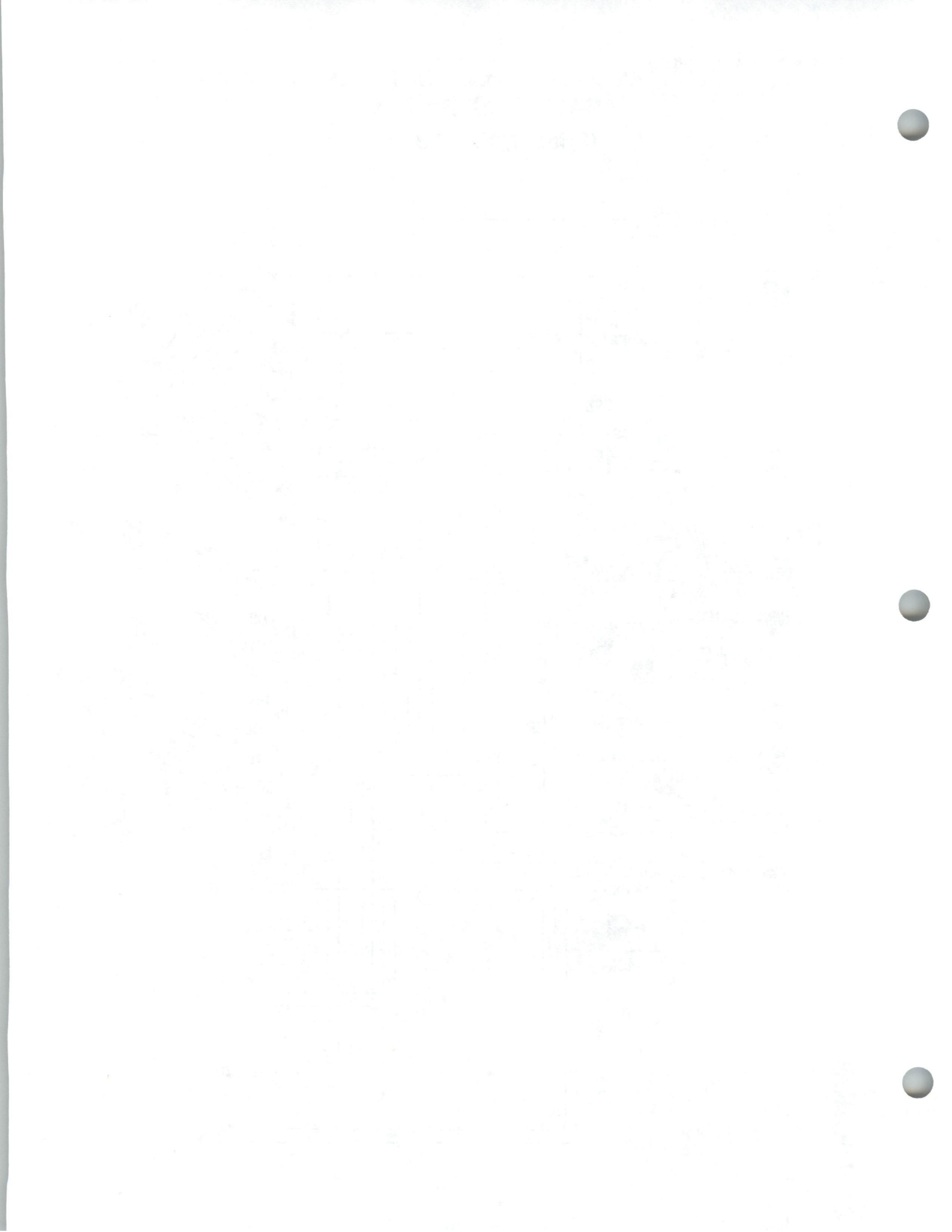



CAB HARNESS

641 (S/N 20001 & Above) 741 (S/N 20001 & Above)
 642 (S/N 20001 & Above) 742 (S/N 20001 & Above)
 642B (S/N 11001 & Above) 743 (S/N 20001 & Above)
 643 (S/N 20001 & Above) 743DS (S/N 51001 & Above)

WIRE LEGEND

NO.'s	COLOR	GAUGE	NO.'s	COLOR	GAUGE
1D	Red	12	31FP	Yellow/Green	18
1F	Red	16	32FPT	Yellow	18
10A	Black	12	32PT	Yellow	18
10B	Black	12	35H	Yellow/Brown	18
12	Orange	16	36	Purple	16
12A	Orange	18	36T	Purple/White	18
12B	Orange	16	40FL	Black	16
12C	Orange	16	40FR	Black	16
12F	Orange	18	40R	Black	16
12L	Orange	18	41	Pink	16
12T	Orange	18	42FL	Dk. Blue	16
19C	Red/White	16	42FR	Dk. Blue	16
19F	Red/White	16	42R	Dk. Blue/White	16
19H	Red/White	18	46	Brown	16
19L	Red/White	16	46L	Brown	16
19S	Red/White	16	46R	Brown	16
19W	Red/White	16	49F	Gray	16
21R	White	16	49T	Gray	16
21RM	White	16	49V	Gray	16
23F	White/Black	16	60W	Black	16
26	Lt. Blue	16	66	Orange/Green	16
28	Lt. Blue/Black	16			
30	Black	16			
30F	Black	16			
30G	Black	16			
30T	Black	16			

PARTS LEGEND

1	Harness Connector	* 16	Light Switch
2	Operator Cab Ground	* 17	Wiper Switch (Optional)
3	Fuel Sender	18	'Trans' Warning Light
4	Back-Up Alarm (Optional)	19	'Eng' Warning Light
5	Rear Lamp	20	Fuse-Ignition
6	Tail Lamp	21	Fuse-Accessory
7	Left Flasher Lamp (Optional)	* 22	Voltmeter
8	Left Front Lamp	23	Ignition Switch
9	Wiper (Optional)	24	Hourmeter
10	Shut Down Module (Optional)		
11	Flasher (Optional)		
12	Right Front Lamp	*	Optional for 642B Only
13	Right Flasher Lamp (Optional)	●	Tea splice
14	Engine Temp. Gauge	○	Butt splice
15	Fuel Gauge		

CAB WIRING DIAGRAM (P/N 6720033)

640, 740

(Printed April 1989)

MC-1121

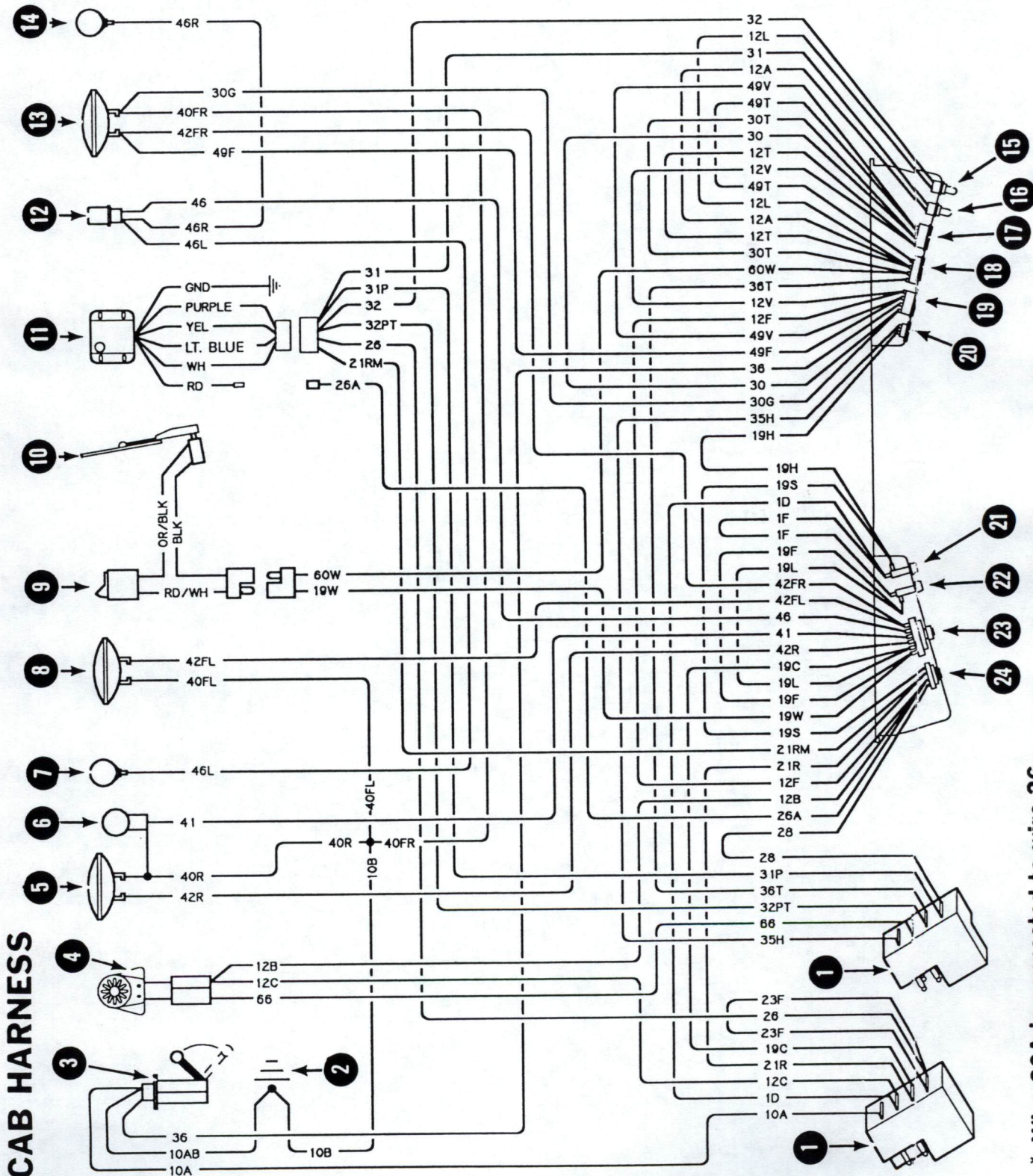

CAB HARNESS

* Wire 26A is connected to wire 26



when module is not used.

CAB HARNESS

641 (S/N 20847 & Above)
 643 (S/N 22556 & Above)
 741 (S/N 20723 & Above)

742 (S/N 21734 & Above)
 743 (S/N 38568 & Above)
 743 DS (S/N 51414 & Above)

WIRE LEGEND

NO.'s	COLOR	GAUGE	NO.'s	COLOR	GAUGE
1D	Red	12	30T	Black	16
1F	Red	16	31	Yellow	18
10A	Black	12	31P	Yellow/Green	18
10B	Black	14	32	Yellow	18
10AB	Black	12	32PT	Yellow	18
12A	Orange	18	35H	Yellow/Brown	18
12B	Orange	16	36	Purple	16
12C	Orange	16	36T	Purple/White	18
12F	Orange	16	40R	Black	16
12L	Orange	18	40FL	Black	16
12T	Orange	18	40FR	Black	16
12V	Orange	18	41	Pink	16
19C	Red/White	16	42FL	Dk. Blue	16
19F	Red/White	16	42FR	Dk. Blue	16
19H	Red/White	18	42R	Dk. Blue/White	16
19L	Red/White	16	46	Brown	16
19S	Red/White	16	46L	Brown	16
19W	Red/White	16	46R	Brown	16
21R	White	16	49F	Gray	18
21RM	White	16	49T	Gray	18
23F	White/Black	16	49V	Gray	18
26	Lt. Blue	16	60W	Black	16
26A	Lt. Blue	16	66	Orange/Green	16
28	Lt. Blue/Black	16			
30	Black	16			
30G	Black	16			

PARTS LEGEND

1	Harness Connectors	17	Voltmeter
2	Ground	18	Temperature Gauge
3	Fuel Sender	19	Fuel Gauge
4	Back-Up Alarm	20	Hourmeter
5	Rear Light	21	Fuse (Ignition)
6	Tail Light	22	Fuse (Accessory)
7	Left Flasher Light (Opt.)	23	Light Switch
8	Left Front Light	24	Ignition Switch
9	Wiper Switch (Opt.)		
10	Wiper		
11	Shut Down Module (Opt.)		
12	Flasher (Opt.)		
13	Right Front Light		
14	Right Flasher Light (Opt.)		
15	Trans. Warning Light		
16	Engine Warning Light		

Faint, illegible text, possibly bleed-through from the reverse side of the page.

CAB WIRING DIAGRAM (P/N 6566808)

640, 740 Series

(Printed April 1988)

CAB HARNESS

641 (S/N 11001-12999)
 642 (S/N 11001-13002)
 643 (S/N 11001-12999)

741 (S/N 11001-11886)
 742 (S/N 11001-12164)
 743 (S/N 11001-14084)

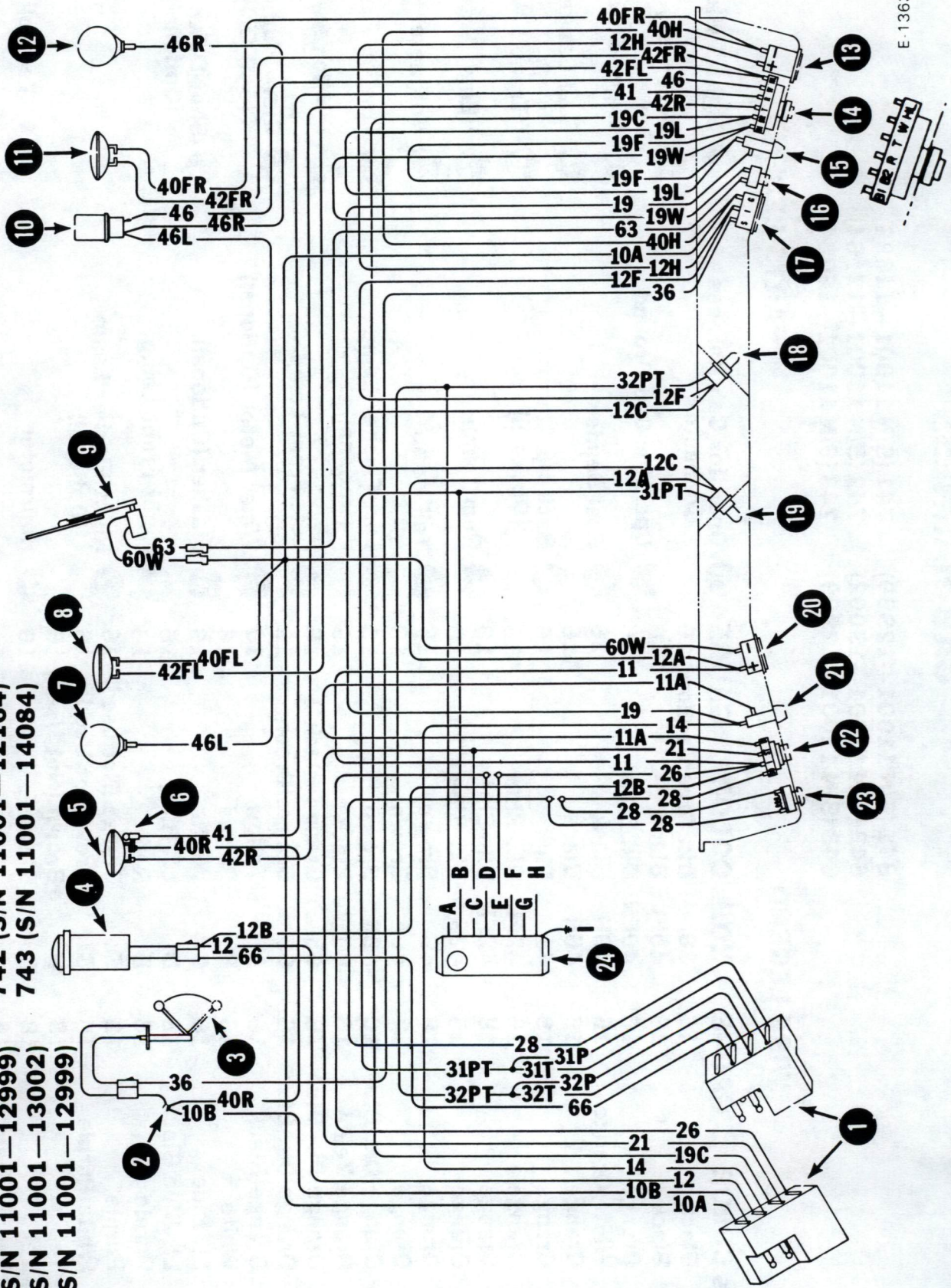

E-1363

13
14
15
16
17
18
19
20
21
22
23
24

CAB HARNESS

641 (S/N 11001—12999) 741 (S/N 11001—11886)
 642 (S/N 11001—13002) 742 (S/N 11001—12164)
 643 (S/N 11001—12999) 743 (S/N 11001—14084)

WIRE LEGEND

NO.'s	COLOR	GAUGE	NO.'s	COLOR	GAUGE
10A	Black	16	36	Dk. Green/Yellow	16
10B	Black	16	40FL	Black	16
11	Orange	16	40FR	Dk. Blue	16
11A	White/Orange	16	40H	Black	16
12	Orange	16	40R	Black	16
12A	Orange	18	41	Pink	16
12B	Orange	16	42FL	Dk. Blue	16
12C	Orange	18	42FR	Dk. Blue	16
12F	Orange	18	42R	Dk. Blue/White	16
12H	Orange	18	46	Brown	16
14	Orange	12	46L	Brown	16
19	Orange/Dk. Blue	16	46R	Brown	16
19C	Orange/Yellow	16	60W	Black	16
19F	Orange/Dk. Blue	16	63	Orange/Black	16
19L	Orange/Dk. Blue	16	66	Orange/Green	16
19W	Orange/Black	16	A	Yellow	16
21	White	16	B	Purple	16
26	Lt. Blue	16	C	White	16
28	Lt. Blue/Black	18	D	Lt. Blue	16
31P	Purple	18	E	Red	16
31PT	Purple	18	F	Orange (Not Used)	16
31T	White/Purple	18	G	Grey (Not Used)	16
32P	Yellow	18	H	Brown (Not Used)	16
32PT	Yellow	18	I	Black	16
32T	Yellow/Black	18			

PARTS LEGEND

1	Operator Cab Harness Connector
2	Operator Cab Ground
3	Fuel Sender
4	Back-Up Alarm (Optional)
5	Rear Lamp
6	Tail Lamp
7	Left Flasher Lamp (Optional)
8	Left Front Lamp
9	Wiper Motor (Optional)
10	Flasher (Optional)
11	Right Front Lamp
12	Right Flasher Lamp (Optional)
13	Hourmeter
14	Light Switch
15	Accessory Fuse
16	Wiper Switch (Optional)
17	Fuel Gauge
18	"Trans" Warning Lamp
19	"Eng" Warning Lamp
20	Voltmeter
21	Ignition Fuse
22	Ignition Switch
23	Glow Plug Indicator (543 Only)
24	Shut-Down Module (Optional)

- Tee splice
- Butt splice

CAB HARNESS

641 (S/N 13001 — 19999) 741 (S/N 11887 — 19999)
 642 (S/N 13003 — 19999) 742 (S/N 12165 — 19999)
 643 (S/N 13001 — 19999) 743 (S/N 14085 — 19999)
 743DS (S/N 50001 — 50999)

WIRE LEGEND

NO.'s COLOR	GAUGE	NO.'s COLOR	GAUGE
1D Red	12	32FPT Yellow	18
1F Red	16	35H Yellow/Brown	18
10A Black	12	36 Purple	16
10B Black	12	36T Purple/White	18
12 Orange	16	40FL Black	16
12A Orange	18	40FR Black	16
12B Orange	16	40R Black	16
12C Orange	16	41 Pink	16
12F Orange	18	42FL Dk. Blue	16
12L Orange	18	42FR Dk. Blue	16
12T Orange	18	42R Dk. Blue/White	16
19C Red/White	16	46 Brown	16
19F Red/White	16	46L Brown	16
19H Red/White	18	46R Brown	16
19L Red/White	16	49F Gray	16
19S Red/White	16	49T Gray	16
19W Red/White	16	49V Gray	16
21RM White	16	60W Black	16
23F White/Black	16	63 Orange/Black	16
26 Lt. Blue	16	66 Orange/Black	16
28 Lt. Blue/Black	16		
30 Black	16		
30F Black	16		
30G Black	16		
30T Black	16		
31FP Yellow/Green	18		

PARTS LEGEND

1	Harness Connector	16	Light Switch
2	Operator Cab Ground	17	Wiper Switch (Optional)
3	Fuel Sender	18	“Trans” Warning Light
4	Back-Up Alarm (Optional)	19	“Eng” Warning Light
5	Rear Lamp	20	Fuse-Ignition
6	Tail Lamp	21	Fuse-Accessory
7	Left Flasher Lamp (Optional)	22	Voltmeter
8	Left Front Lamp	23	Ignition Switch
9	Wiper (Optional)	24	Hourmeter
10	Shut Down Module (Optional)		
11	Flasher (Optional)		
12	Right Front Lamp		
13	Right Flasher Lamp (Optional)		
14	Engine Temp. Gauge		
15	Fuel Gauge		

● Tee splice
 ○ Butt splice

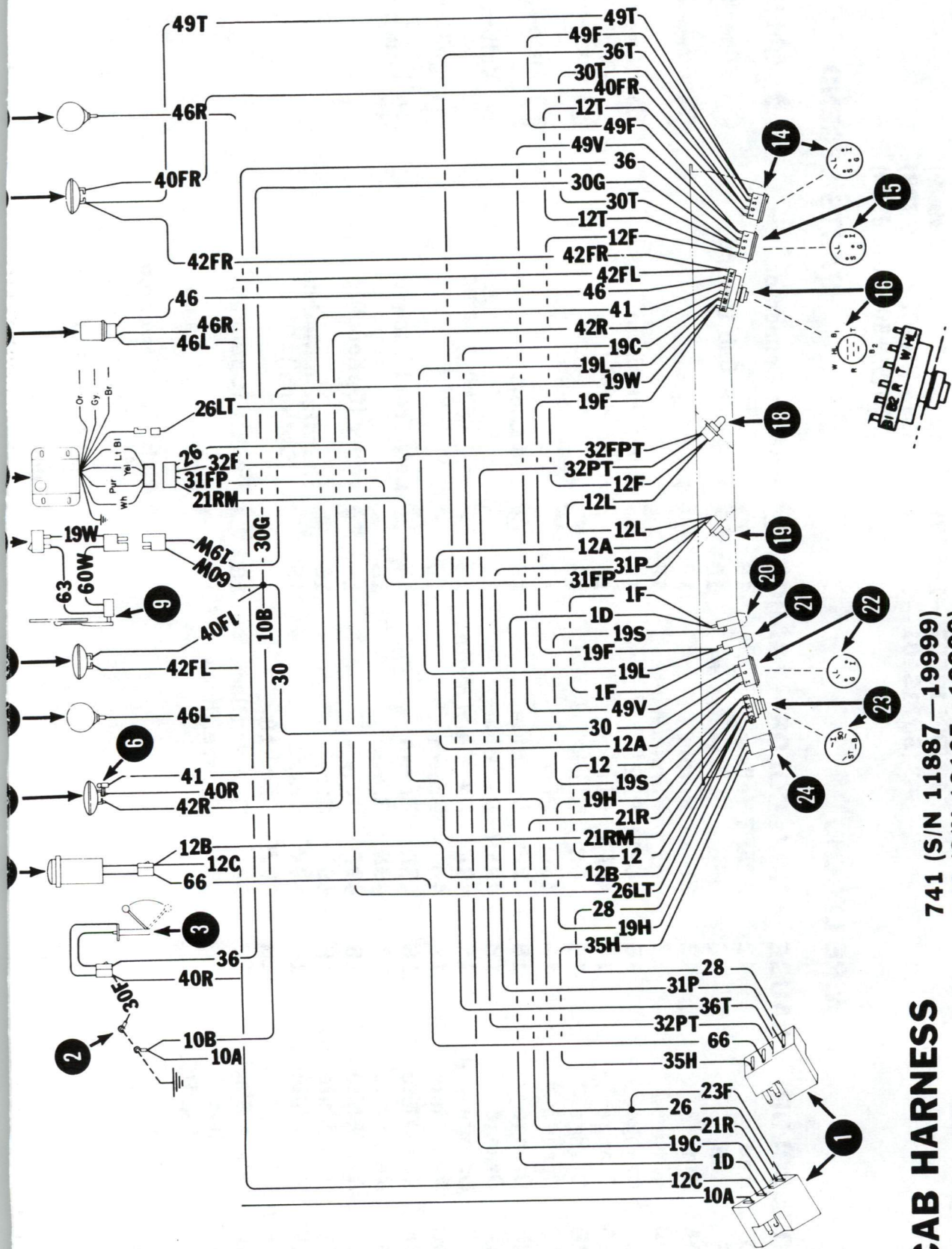

741 (S/N 11887—19999)
 742 (S/N 12165—19999)
 743 (S/N 14085—19999)
 743DS (S/N 50001—50999)

CAB HARNESS
 641 (S/N 13001—19999)
 642 (S/N 13003—19999)
 643 (S/N 13001—19999)

ENGINE HARNESS

641 (S/N 11001-12999)
741 (S/N 11001-11885)

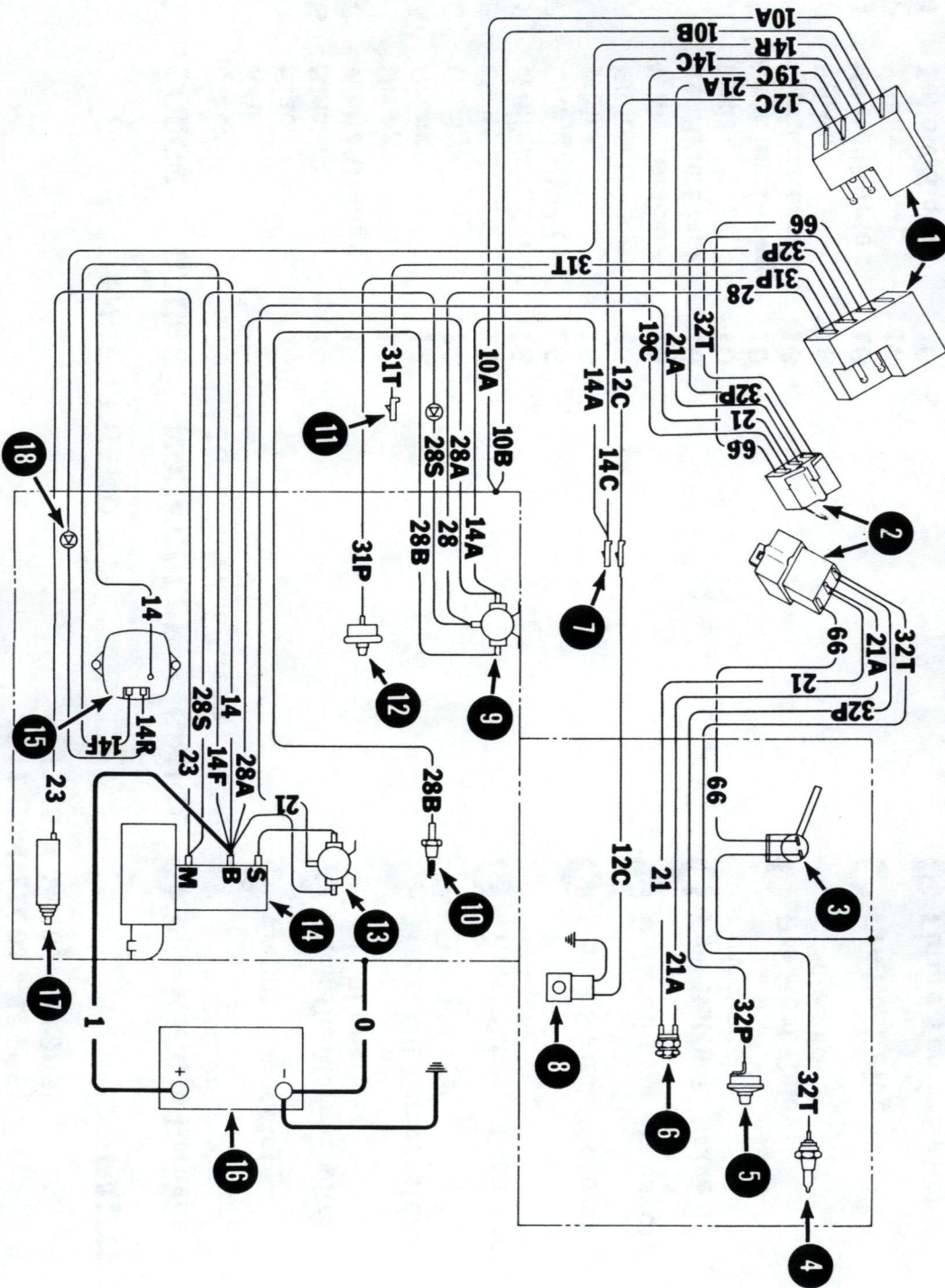

ENGINE WIRING DIAGRAM (P/N 6566809) Model 641, 741 (Printed April 1988)

E-1357

ENGINE HARNESS

641 (S/N 11001—12999)
741 (S/N 11001—11885)

WIRE LEGEND

NO.'s	COLOR	GAUGE
0	Black	Cable
1	Red	Cable
10A	Black	16
10B	Black	16
12C	White/Orange	16
14	Orange	12
14A	Orange	12
14C	Orange	12
14F	Light Green	16
14R	White/Lt. Green	16
19C	Orange/Yellow	16
21	White	16
21A	White	16
23	White/Black	16
28	Lt. Blue/Black	16
28A	Red	10
28B	Lt. Blue/Orange	10
28S	White/Green	16
31P	Purple	16
31T	White/Purple	16
32P	Yellow	16
32T	Yellow/Black	16

NO.'s	COLOR	GAUGE
66	Orange/Green	16

PARTS LEGEND

- ① Operator Cab Harness Connector
- ② Engine Connector
- ③ Back-Up Alarm Switch (Optional)
- ④ Trans. Oil Temperature Sender
- ⑤ Trans. Charge Pressure Sender
- ⑥ Brake Switch (Future)
- ⑦ Unfused Live Accessory
- ⑧ Fuel Solenoid Valve (Optional)
- ⑨ Pre-Heat Relay Solenoid
- ⑩ Pre-Heat Plug
- ⑪ Future Temp. Switch
- ⑫ Engine Oil Pressure Sender
- ⑬ Starter Relay Solenoid
- ⑭ Starter
- ⑮ Alternator
- ⑯ Battery
- ⑰ Excess Fuel Solenoid
- ⑱ Diode

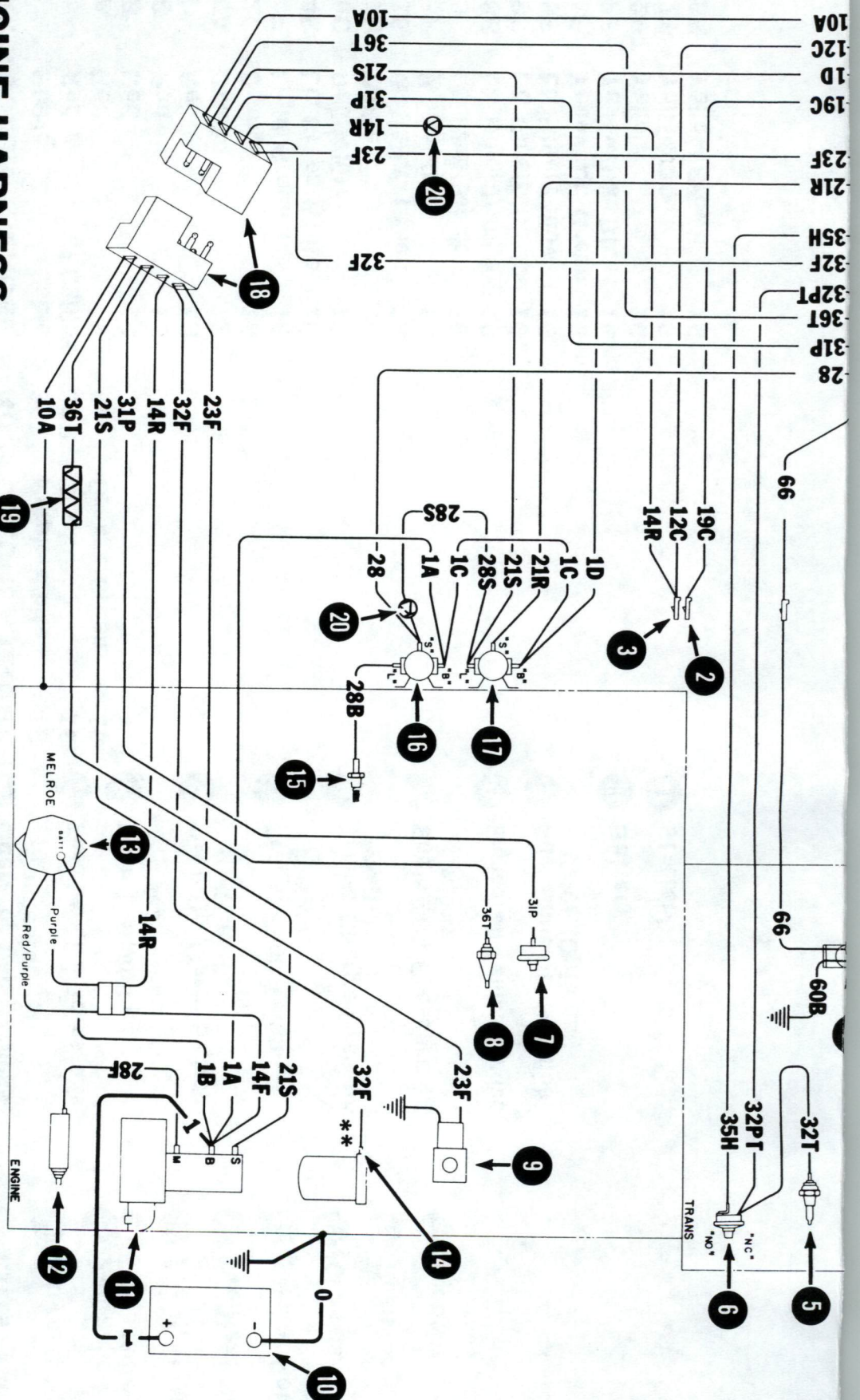

ENGINE HARNESS

- * 641 (S/N 13001 — 20408) Delco
- * 741 (S/N 11886 — 20320) Delco
- 641 (S/N 20409 & Above) Melroe
- 741 (S/N 20321 & Above) Melroe



- ** Hydraulic Fluid Filter Pressure Switch (Item 14, Wire #32F) was added at S/N 15001 for Model 741 and S/N 13209 for Model 641.

ENGINE HARNESS

* 641 (S/N 13001 — 20408) Delco
 * 741 (S/N 11886 — 20320) Delco
 641 (S/N 20409 & Above) Melroe
 741 (S/N 20321 & Above) Melroe

WIRE LEGEND

NO.'s	COLOR	GAUGE	NO.'s	COLOR	GAUGE
0	Black	Cable	36T	Purple/White	16
1	Red	Cable	60B	Black	16
1A	Red	8	66	Orange/Green	16
1B	Red	10			
1C	Red	12			
1D	Red	12			
10A	Black	12			
12C	Orange	16			
14F	Light Green	16			
14R	Lt. Green/White	16			
19C	Red/White	12			
21R	White	16			
21S	White/Lt. Green	12			
23F	White/Blue	16			
28	Lt. Blue/Black	16			
28B	Lt. Blue/Orange	10			
28F	Lt. Blue/Dk. Blue	16			
28S	Lt. Blue/Yellow	16			
31P	Yellow/Lt. Green	16			
32F	Yellow/Dk. Blue	16			
32PT	Yellow	16			
32T	Yellow/Black	16			
35H	Yellow/Brown	16			

PARTS LEGEND

- | | |
|---|---|
| ① Operator Cab Harness Connector | ⑫ Excess Fuel Solenoid |
| ② Fused & Live Accessories | ⑬ Alternator |
| ③ Fuse & Switched Accessories | ** ⑭ Hydraulic Fluid Filter Pressure Switch |
| ④ Back-Up Alarm Switch (Optional) | ⑮ Pre-Heat Glow Plug |
| ⑤ Trans. Fluid Temp. Switch | ⑯ Pre-Heat Relay |
| ⑥ Trans. Charge Pressure Switch | ⑰ Starter Relay |
| ⑦ Engine Oil Pressure Switch | ⑱ Chassis Connector |
| ⑧ Engine Oil Temp. Sender | ⑲ Resistor |
| ⑨ Fuel Shut-Off Solenoid Valve (Optional) | ⑳ Diode |
| ⑩ Battery | |
| ⑪ Starter | |

ENGINE WIRING DIAGRAM (P/N 6566810)

Models 642, 742

(Printed April 1988)

E-1358

ENGINE HARNESS

642 (S/N 11001—13002)

742 (S/N 11001—12164)

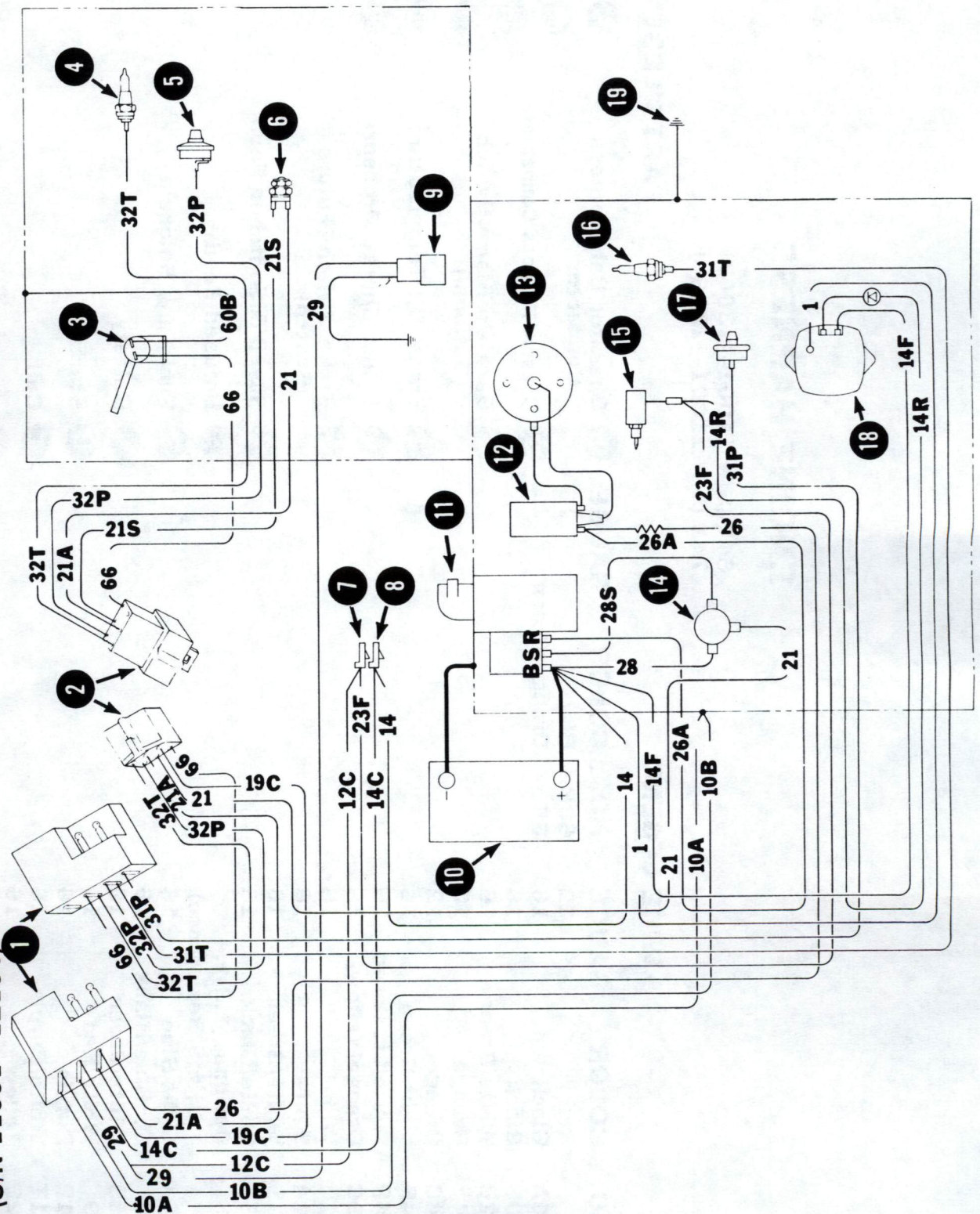

ENGINE HARNESS

642 (S/N 11001—13002)
741 (S/N 11001—12164)

WIRE LEGEND

NO.'s COLOR	GAUGE	NO.'s COLOR	GAUGE	Operator Cab Harness Connector	Power Relay
1 Red	12	60B Black	16	1 Operator Cab Harness Connector	14 Power Relay
10A Black	16	66 Orange/Green	16	2 Chassis Harness Connector	15 Carburetor Fuel Solenoid
10B Black	16			3 Back-Up Alarm Switch (Optional)	16 Engine Water Temp.
12C White/Orange	16			4 Trans. Oil Temperature	17 Engine Oil Pressure
14 Orange	12			5 Trans. Charge Pressure	18 Alternator
14C Orange	12			6 Brake Switch (Future Switch)	19 Engine to Frame Ground
14F Light Green	16			7 Fused & Switched Feed	Diode (Keeps engine from running after ignition is turned off)
14R White/Lt. Green	16			8 Unfused Feed	
19C Orange/Yellow	16			9 Fuel Tank Solenoid	
21 White	16			10 Battery	
21A White	16			11 Starter	
21S White/Green	16			12 Coil	
23F White/Black	16			13 Distributor	
26 Optional (1.3-1.4 OHMS Resistance)	16				
26A Light Blue	16				
28 Lt. Blue/Black	16				
28S White/Green	16				
29 White/Red	18				
31P Purple	16				
31T White/Purple	16				
32P Yellow	16				
32T Yellow/Black	16				

PARTS LEGEND

ENGINE HARNESS

- * 642 (S/N 13003 — 20840) Delco
- * 742 (S/N 12165 — 20881) Delco
- 742 (S/N 20882 & Above) Melroe

WIRE LEGEND

NO.'s COLOR	GAUGE	NO.'s COLOR	GAUGE
0	Cable	60B Black	16
1	Cable	66 Orange/Green	16
1B	10		
1C	12		
1D	12		
10A	12		
12C	16		
14F	16		
14R	16		
19C	16		
21R	16		
21S	12		
23F	16		
26	Color Optional (1.3-1.4 OHMS Resistance)		
26A	Lt. Blue/Green		16
29	White/Red		18
31P	Yellow/Lt. Green		16
* 32F	Yellow/Dk. Blue		16
32PT	Yellow		16
32T	Yellow/Black		16
35H	Yellow/Brown		16
36T	Purple/White		16

PARTS LEGEND

1	Operator Cab Harness Connector	13	Engine Oil Pressure Switch
2	Fused & Live Accessories	** 14	Hydraulic Fluid Filter Pressure Switch
3	Fuse & Switched Accessories	15	Diode
4	Back-Up Alarm Switch (Optional)	16	Alternator
5	Trans. Fluid Temp. Switch	17	Starter Relay
6	Trans. Charge Pressure Switch	18	Battery
7	Fuel Tank Solenoid		
8	Starter		
9	Coil		
10	Distributor		
11	Carburetor Fuel Solenoid		
12	Engine Water Temp. Sender		

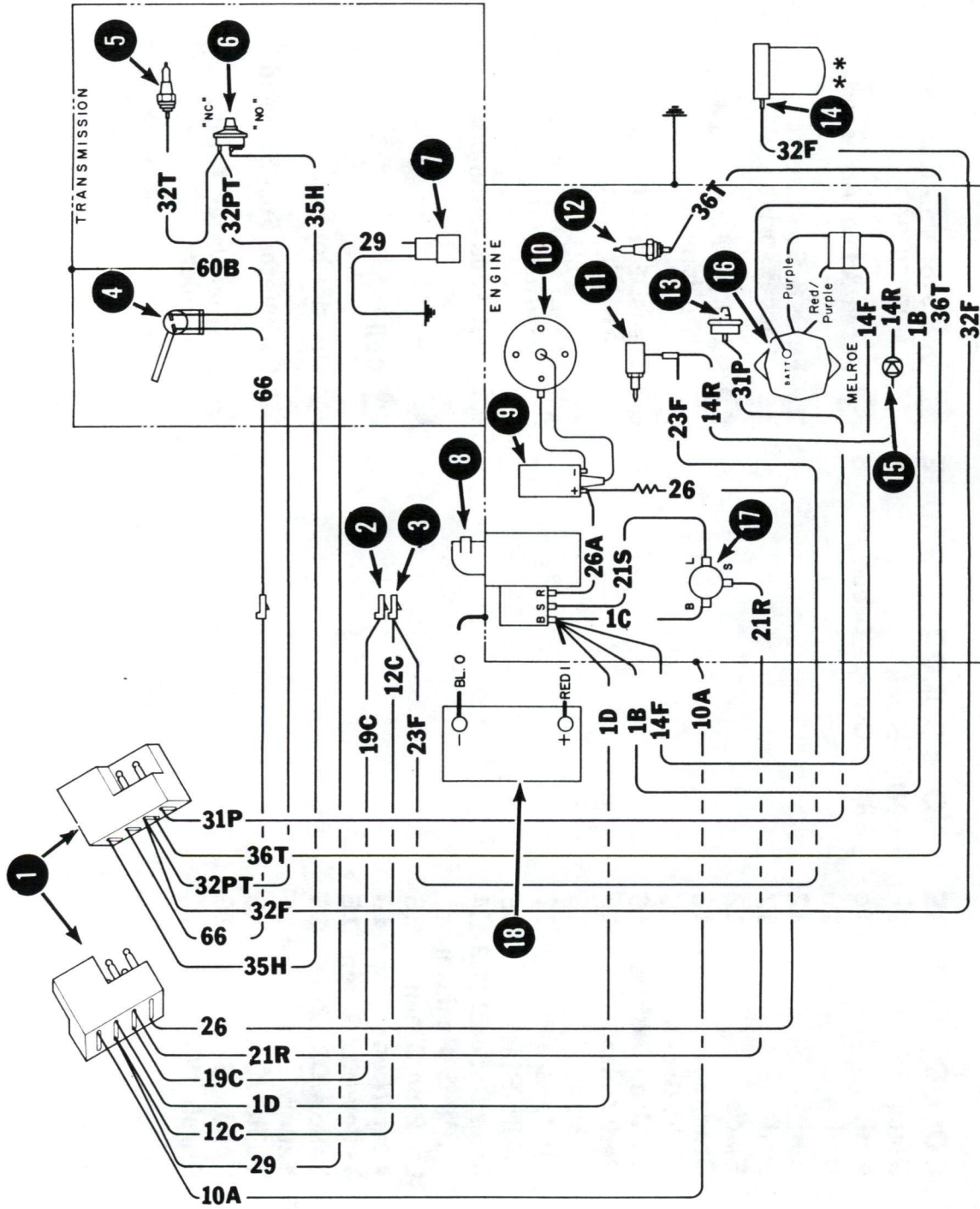

ENGINE HARNESS

- * 642 (S/N 13003 — 20840) Delco
- * 742 (S/N 12165 — 20881) Delco
- 742 (S/N 20882 & Above) Melroe

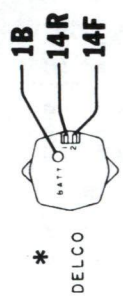

* DELCO

** Hydraulic Fluid Filter Pressure Switch (Item 14, Wire #32F) was added at S/N 15001 for Model 742 and S/N 13524 for Model 642.

ENGINE WIRING DIAGRAM (P/N 6566811)

Models 643, 743
(Printed April 1988)

ENGINE HARNESS

643 (S/N 11001-12999)

743 (S/N 11001-14084)

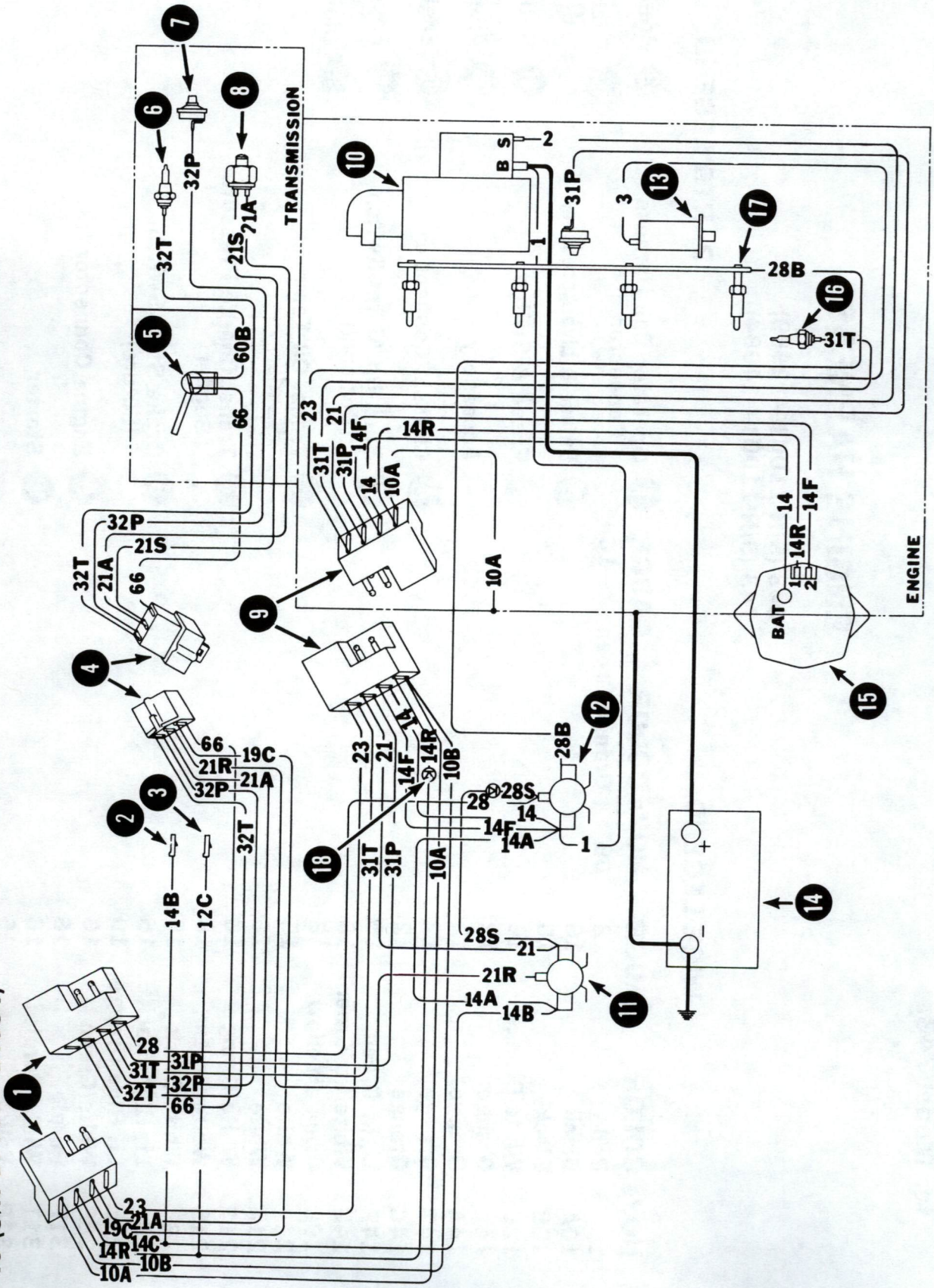

*** 16 gauge on S/N 13001—13383 for Model 643 and S/N 14085—14999 for Model 743.

ENGINE HARNESS

643 (S/N 11001—12999)
743 (S/N 11001—14084)

WIRE LEGEND

NO.'s	COLOR	GAUGE	NO.'s	COLOR	GAUGE
1	Red	8	1	Orange/Green	16
10A	Black	16	2	Unfuse & Live Accessory	
10B	Black	16	3	Fused & Switch Accessory	
12C	White/Orange	16	4	Chassis Connector	
14	Orange	12	5	Back-Up Alarm Switch (Optional)	
14A	Orange	12	6	Trans. Oil Temp. Sender	
14B	Orange	12	7	Trans. Charge Pressure Sender	
14C	Orange	12	8	Brake Start Switch (Future)	
14F	Light Green	16	9	Engine Connector	
14R	White/Lt. Green	16	10	Starter	
19C	Orange/Yellow	16	11	Start Relay	
21	White	16	12	Pre-Heat Relay	
21A	White	16	13	Fuel Shut-Off Solenoid (Optional)	
21R	White/Orange	16	14	Battery	
21S	White/Green	16	15	Alternator	
23	White/Black	16	16	Engine Coolant Temp.	
28	Lt. Blue/Black	16	17	Engine Glow Plugs	
28B	Lt. Blue/Orange	10	18	Diode	
28S	White/Green	16			
31P	Purple	16			
31T	White/Purple	16			
32P	Yellow	16			
32T	Yellow/Black	16			
60B	Black	16			

PARTS LEGEND

- 1 Operator Cab Harness Connector
- 2 Unfuse & Live Accessory
- 3 Fused & Switch Accessory
- 4 Chassis Connector
- 5 Back-Up Alarm Switch (Optional)
- 6 Trans. Oil Temp. Sender
- 7 Trans. Charge Pressure Sender
- 8 Brake Start Switch (Future)
- 9 Engine Connector
- 10 Starter
- 11 Start Relay
- 12 Pre-Heat Relay
- 13 Fuel Shut-Off Solenoid (Optional)
- 14 Battery
- 15 Alternator
- 16 Engine Coolant Temp.
- 17 Engine Glow Plugs
- 18 Diode

ENGINE HARNESS

- * 643 (S/N 13001 — 21230) Delco
- * 743 (S/N 14085 — 27387) Delco
- 643 (S/N 21231 & Above) Melroe
- 743 (S/N 27388 & Above) Melroe

WIRE LEGEND

NO.'s COLOR	GAUGE	NO.'s COLOR	GAUGE	1	2	3	4	5	6	7	** 8	9	10	11	12	13	14	15	16	17	18	
0	Black	60B	Black	16	Operator Cab Harness Connector	Engine Coolant Temp. Sender																
1	Red	66	Orange/Green	16	Fused & Live Accessories	Alternator																
1A	Red	8			Fuse & Switched Accessories	Battery																
1B	Red	10**			Chassis Connector	Pre-Heat Relay																
1C	Red	12			Back-Up Alarm Switch (Optional)	Start Relay																
1D	Red	12			Trans. Fluid Temp. Switch	Diode																
10A	Black	12			Trans. Charge Pressure Switch																	
12C	Orange	16			Hyd. Fluid Filter Pressure Switch																	
14F	Light Green	16			Starter																	
14R	Lt. Green/White	16			Engine Glow Plugs																	
19C	Red/White	16			Engine Oil Pressure Switch																	
21R	White	16			Fuel Shut-Off Solenoid (Optional)																	
21S	White/Green	12***																				
23F	White/Black	16																				
28	Lt. Blue/Black	16																				
28B	Lt. Blue/Orange	10																				
28S	Lt. Blue/Yellow	16																				
31P	Yellow/Lt. Green	16																				
32F ³	Yellow/Dk. Blue	16																				
32PT	Yellow	16																				
32T	Yellow/Black	16																				
35H	Yellow/Brown	16																				
36T	Purple/White	16																				

** 12 gauge on S/N 13001—21230 for Model 643 and S/N 14085—27387 for Model 743.

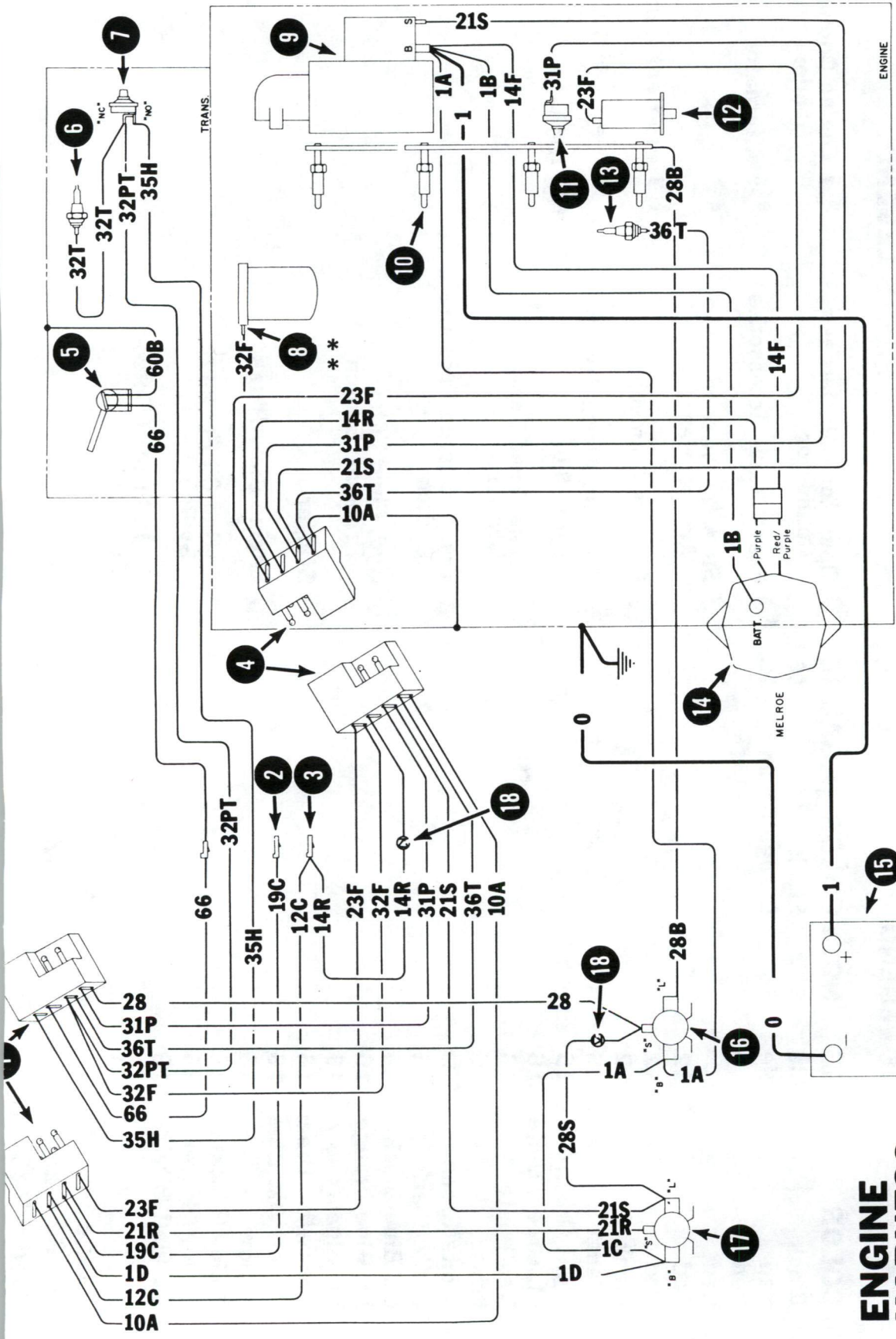

ENGINE HARNESS

- * 643 (S/N 13001 — 21230) Delco
- * 743 (S/N 14085 — 27387) Delco
- 643 (S/N 21231 & Above) Melroe
- 743 (S/N 27388 & Above) Melroe

** Hydraulic fluid pressure switch (Item 8, Wire #32F) was added at S/N 13384 for Model 643 and S/N 15001 for Model 743.

* DELCO

ENGINE WIRING DIAGRAM (P/N 6570758)

Model 743DS

(Printed September 1990)

E-1495

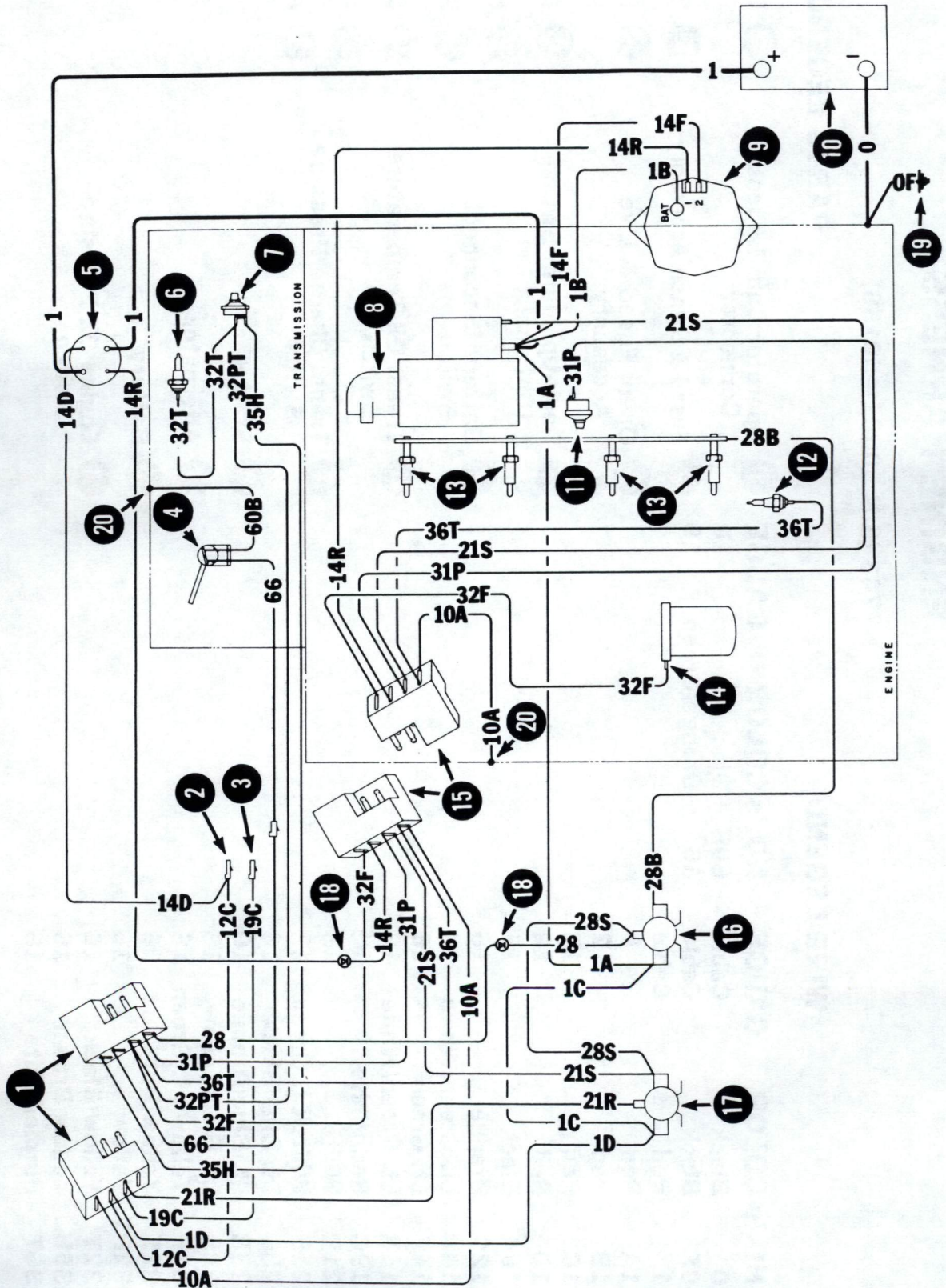

ENGINE HARNESS
743DS (S/N 50001-50156)

ENGINE HARNESS

743 (S/N 50001—50156)

WIRE LEGEND

NO.'s COLOR	GAUGE	NO.'s COLOR	GAUGE	1	2	3	4	5	6	7	8	9	10	11
0	Black	60B	Black	16	Operator Cab Harness Connector	12	Engine Coolant Temp. Sender							
0F	Black	66	Orange/Green	16	Fused & Switch Accessory	13	Engine Glow Plugs							
1	Red					14	Hyd. Fluid Filter Condition Switch							
1A	Red					15	Engine Connector							
1B	Red					16	Pre-Heat Relay							
1C	Red					17	Starter Relay							
1D	Red					18	Diode							
10A	Black					19	Frame Ground							
12C	Orange					20	Engine Ground							
14D	Lt. Green/White													
14F	Lt. Green													
14R	Lt. Green/White													
19C	Red/White													
21R	White													
21S	White/Lt. Green													
28	Lt. Blue/Black													
28B	Lt. Blue/Orange													
28S	Lt. Blue/Yellow													
31P	Yellow/Lt. Green													
32F	Yellow/Dk. Blue													
32PT	Yellow													
32T	Yellow/Black													
35H	Yellow/Brown													
36T	Purple/White													

PARTS LEGEND

ENGINE HARNESS

743DS (S/N 50157 thru 51377)

WIRE LEGEND

NO.'s COLOR	GAUGE	NO.'s COLOR	GAUGE	1	2	3	4	5	6	7	8	9	10	11	12	13	14	15	16	17	18	19	20	21
0 Black	Cable	60B Black	16	Operator Cab Harness Connector	Engine Coolant Temp. Sender																			
1 Red	Cable	66 Orange/Green	16	Fused & Switch Accessory	Engine Glow Plugs																			
1A Red	8			Open, Fused & Live Accessory	Hyd. Fluid Filter Condition Switch																			
1B Red	12			Back-Up Alarm Switch (Optional)	Engine Connector																			
1C Red	12			Battery Disconnect Switch	Pre-Heat Relay																			
1D Red	12			Trans. Oil Temperature Switch	Starter Relay																			
10A Black	12			Trans. Charge Pressure Switch	Diode																			
12C Orange	16			Starter	Frame Ground																			
14F Lt. Green	16			Alternator	Engine Ground																			
14R Lt. Green/White	16			Battery	Fuel Shut-Off Solenoid (Optional)																			
19C Red/White	12			Engine Oil Pressure Switch																				
21R White	16																							
21S White/Lt. Green	12																							
23F White/Black	16																							
28 Lt. Blue/Black	16																							
28B Lt. Blue/Orange	10																							
28S Lt. Blue/Yellow	16																							
31P Yellow/Lt. Green	16																							
32F Yellow/Dk. Blue	16																							
32PT Yellow	16																							
32T Yellow/Black	16																							
35H Yellow/Brown	16																							
36T Purple/White	16																							

PARTS LEGEND

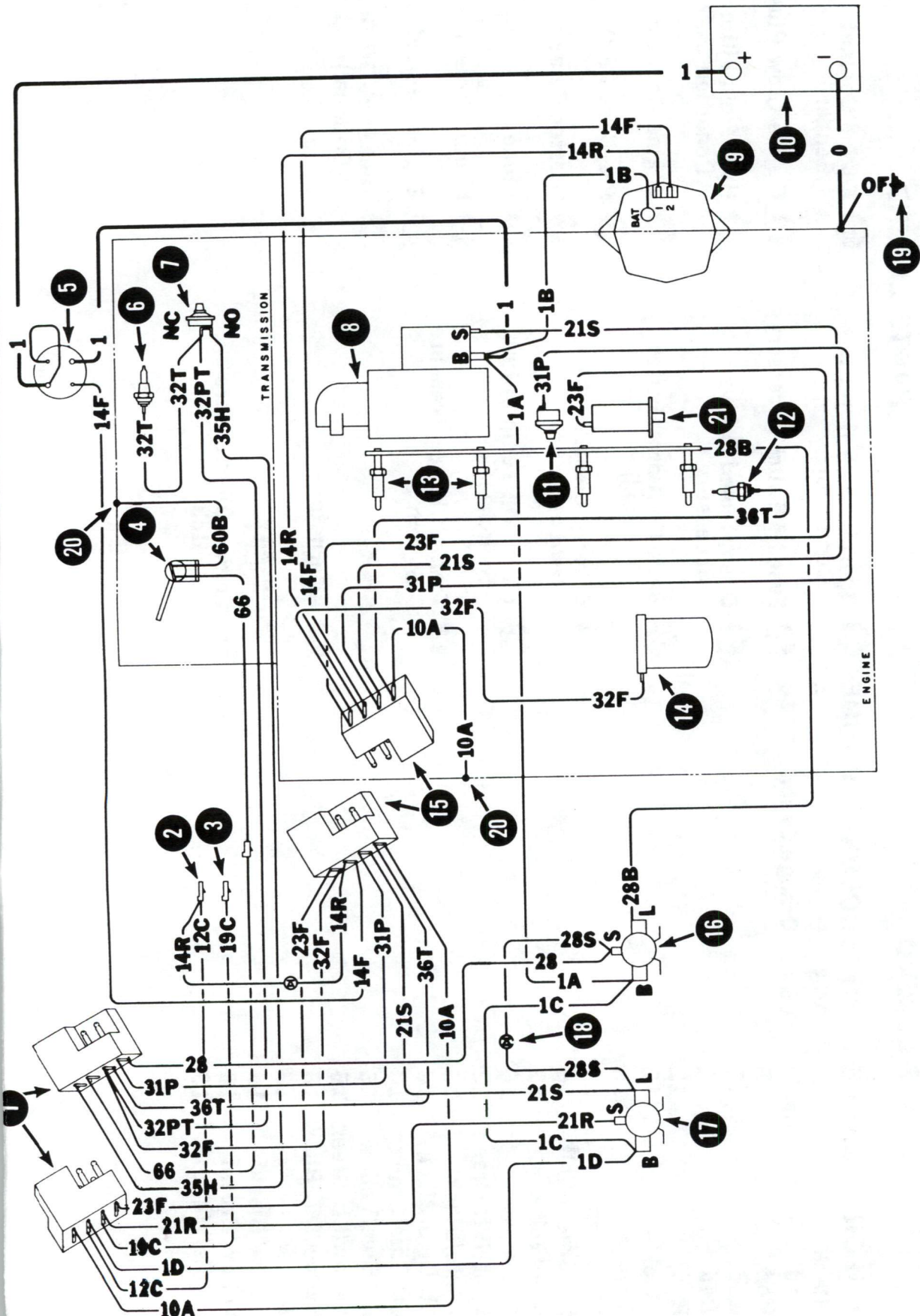

ENGINE HARNESS
 743DS (S/N 50157 thru 51377)